

YAMAHA

RIDER'S MANUAL

X52
650



YAMAHA MOTOR CO., LTD.

PRINTED IN JAPAN

306-28199-10

FOREWORD

The new Yamaha XS2, is Yamaha's first four-stroke engine motorcycle. The engine is of an overheadcam type (O.H.C.), having a displacement of 650 cc.

This XS2 combines high speed roadability and excellent maneuverability to make itself a real high performance sportster.

It also assures superior durability.

This owner's manual contains the technical information required to service the XS2 so that it is always in good working condition.

TABLE OF CONTENTS

Forward	1
Table of contents	2
Nomenclature	3
Service Notes & Tools	5
Features	6
Controls	9
Basic Instructions	16
Operation	17
Maintenance	20
Break In	21
Inspection and Service	22
Servicing	24
Cables	24
Clutch Adjustment	24
Drive Chain	31
Battery	35
Timing	37
Ignition Points	38
Spark Plug	38
Engine Oil	39
Oil Filter	41
Oil Screen	41
Steering	42
Rear Suspension	42
Valve Adjustment	43
Cam Drive Chain	45

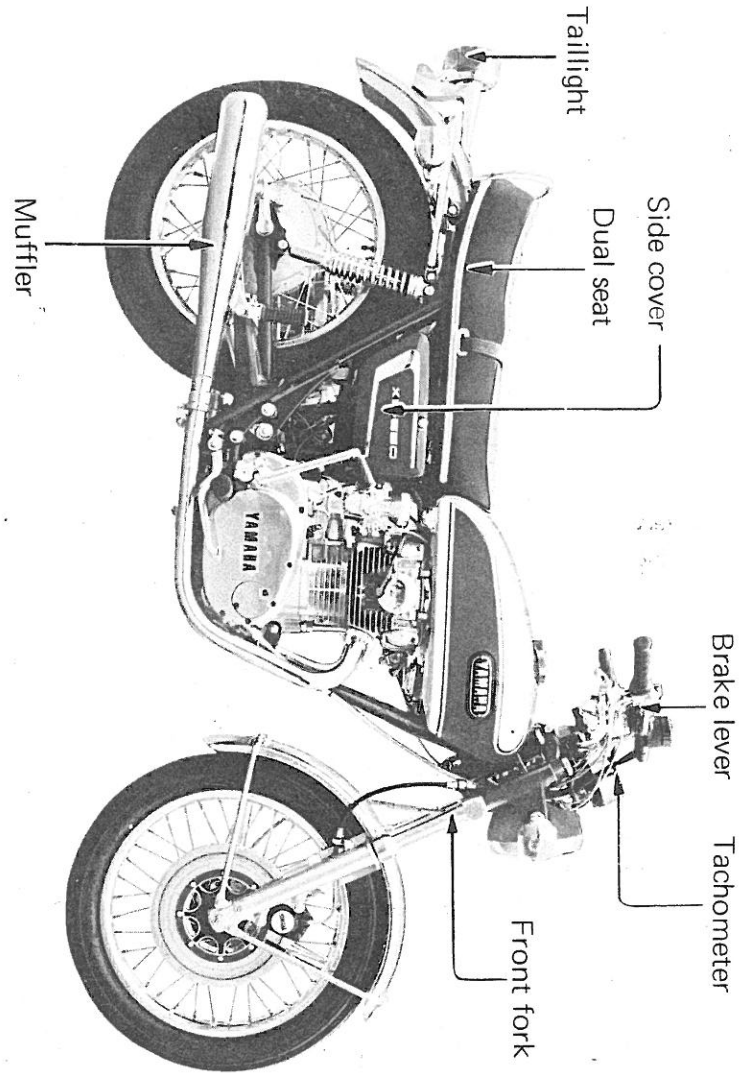

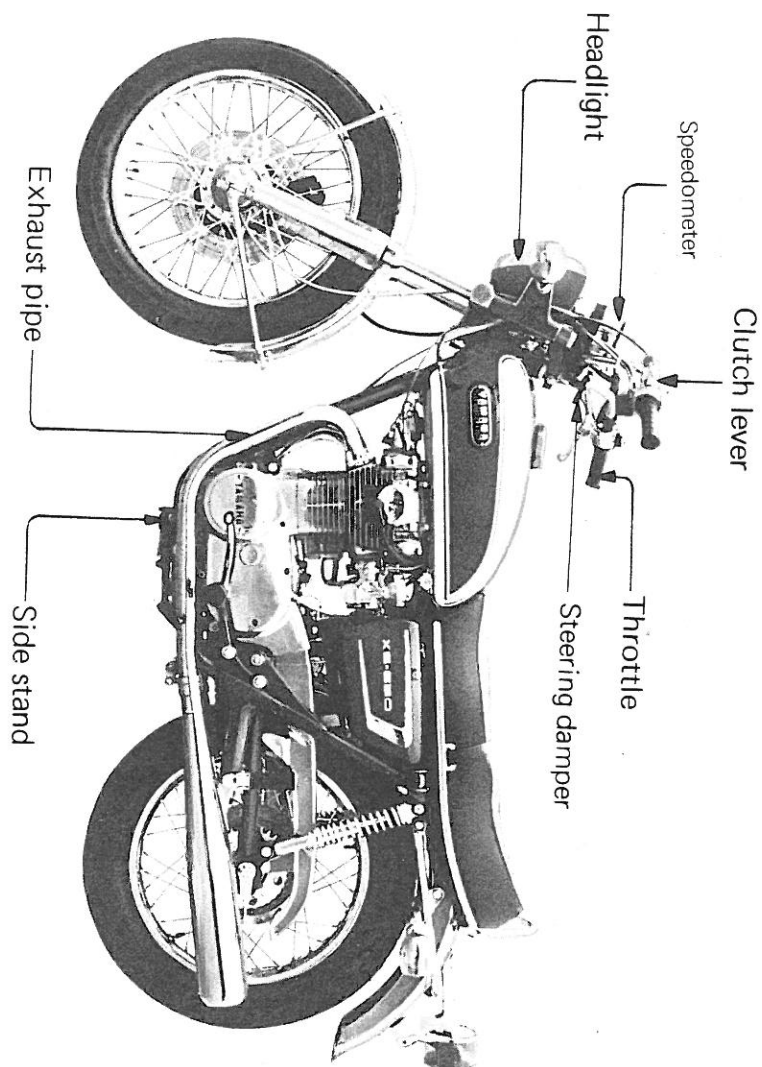

SERVICE NOTES and SPECIAL TOOLS

The servicing information included in this manual is intended to provide you, the owner, with the necessary information to provide a means of doing your own preventive maintenance and minor repairs.

The tools provided in the owner's tool kit are sufficient for this purpose.

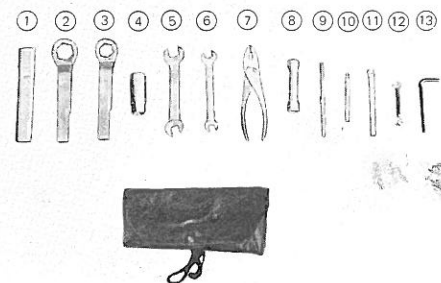

- | | |
|--------------------------|---|
| 1 Extension bar | 8 Box spanner 12 mm |
| 2 Socket wrench 27 mm | 9 \oplus \ominus driver |
| 3 Socket wrench 22 mm | 10 \oplus driver |
| 4 Box spanner 21 x 23 mm | 11 Tappet spanner |
| 5 Spanner 13 x 17 mm | 12 Point spanner 0.15,0.30,0.35
(mm) |
| 6 Spanner 10 x 12 mm | 13 Hex wrench. |
| 7 Pliers | |

The XS2, because of its four-stroke design, is more complex than previous Yamaha two-stroke engines. For this reason such procedures as decarbonizing, etc., must be performed by an Authorized Yamaha Dealer and are not included in this manual.

Should you desire additional service information on your XS650 a copy of the Service Manual can be purchased from any Authorized Dealer or direct from the Literature Department, Yamaha International Corp., P.O.Box 54540, Los Angeles, Calif. 90054
(Canadian Distributor: Fred Deeley Ltd., 854 West 6th, Vancouver, B.C., Canada)

FEATURES OF XS650

FOUR-CYCLE O.H.C. ENGINE

The Yamaha XS2 is equipped with Yamaha's first four-stroke, parallel twin cylinder, O.H.C. engine. This new engine has been developed fully utilizing Yamaha's experience in the manufacture of the four-stroke engines adopted for the Toyota 2000GT and the Toyota 7.

The high-performance engine is mounted on a double-cradle type steel tube frame which features light weight and high rigidity. With a combination of high horsepower and well-balanced transmission, the XS2 exhibits outstanding acceleration which is essential to a large displacement, high-performance sportster.

1) PERFORMANCE

In order to increase the intake efficiency of the air-fuel mixture, the combustion chamber is hemispherical. In addition to over-sized valves, the SU type carburetor is employed. Consequently, engine performance is steady throughout the speed range from idling speed to high speed.

2) VALVE AND CAMSHAFT MECHANISM

The valve mechanism employs the O.H.C. system which is most suitable for a high speed, high output engine. A single row endless chain is used as the cam drive. A chain guide and chain tensioner are employed to minimize the vibration and noise of the cam chain. The control of vibrations stabilizes the valve action at high speed. In addition, double springs are used for the valves in order to prevent surging of the valves at high rpm's.

3) SU TYPE CARBURETOR WITH BUILT-IN STARTER

The XS2 is equipped with SU type twin carburetors. This carburetor is equipped with a variable venturi. That is, the section area of the venturi automatically changes according to fluctuations of the negative pressure in the intake manifold. This type carburetor is capable of supplying fuel at the correct ratio according to the air flow throughout the speed range, thus assuring excellent acceleration. The built-in starter is most effective in starting the

engine in cold weather.

4) LUBRICATION SYSTEM WITH TROCHOID PUMP

The oil pump is the trochoid type, driven by means of a crankshaft gear. A pressure-feed lubrication system is employed. The oil filter, made of long-lasting wire netting, is of a double-filtrating type, and thereby the wear of the engine will be effectively minimized.

5) WELL-BALANCED 5-SPEED TRANSMISSION

Coupled with the well-balanced 5-speed transmission, the XS2 engine assures steady engine performance under any road conditions such as city streets, hills, high-speed highways, etc.

6) WELL-PROPORTIONED FRAME AND LIGHT WEIGHT

The XS2 uses a double-cradle frame which is best suited to its high output, large displacement engine and thus features superiority in maneuverability, stability, and durability. The over-all weight is lighter than other makes in the same class; that is, weight per horsepower is the most effective.

7) ADOPTION OF DISC BRAKE

The large size disc brake has been adopted to ensure efficiency in steady braking both at low and high speeds and in rainy weather.

8) THREE-WAY ADJUSTABLE REAR SUSPENSION

The XS2 uses a three-way adjustable rear suspension. The spring tension can be adjusted according to the rider's option and road conditions. The cushion stroke is 70 mm (2.75"). An oil lock system is employed as a shock-absorber and to prevent bottoming.

9) AIR CLEANER

A larger air cleaner is used compared with that for other motorcycles in the same class. The paper filter element has an oversize filtering area for improved air intake efficiency. Coupled with the SU type carburetor the superior acceleration and economy are ensured.

10) BRIGHT HEAD LAMP

The head lamp is 170 mm (6.7") in diameter with a 12V 50/40W bulb. Additional safety is guaranteed at night. The head lamp unit is of a special sealed beam type in which the bulb is rubber mounted.

11) DOUBLE-EDGED KEY

The double-edged main switch key is designed to allow the rider to insert the key more readily.

12) INSTALLATION OF ELECTRIC STARTER

The XS2 is equipped with electric switch built-in decompression.

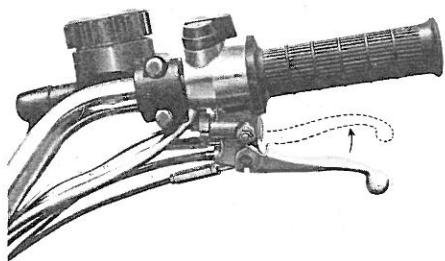

Control Functions

1) Main Switch

The main switch has three positions; Off, Ignition and Parking

The key can be removed in the parking position.

The following table shows the electrical connections with the key in each position.

(The circle indicates the "Key" position)

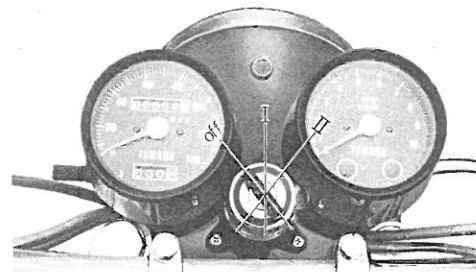

	Off	I	II	
Engine		○		Kick the pedal or pull up the decompression lever.
Neutrallight		○		When shifted to neutral.
Meterlight		○		When light switch is turned on.
Headlight		○		"
Taillight		○	○	"
Stoplight		○		When the brake is applied.
High beam indicator		○		When the headlight high beam is turned on.
Horn		○		Push the horn button.
Flasherlight		○		Turn on left handlebar switch.

2) Fuel Petcock

A fuel petcock is located on each side of the fuel tank. When the lever is turned downward, it is set to "ON," and fuel begins to flow. If the fuel stops flowing with the lever "ON," turn the lever to "RESERVE." The fuel remaining in the tank is 2.5 liters, with which the machine may travel a distance of 20 to 25 miles

more before the tank becomes empty.

When parking or storing the machine, the fuel cock lever should be set to "STOP".

The XS2 uses the same petcock on both sides of the fuel tank.

Therefore, when the petcocks are in the "RESERVE" position for example, the lever on the left petcock will point in an opposite direction from the lever on the right. The photograph below shows a petcock in the "RESERVE" position. (position marked with dotted lines).

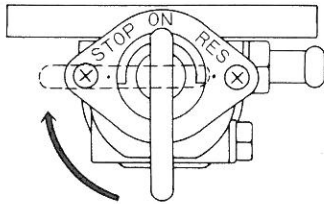

(4) Handle Lever Switch

- Light switch: When the switch is pushed up, the headlight, meter lamp and tail lamp are turned on.
- Dimmer switch: When the dimmer switch is pushed up, the head light is switched to low beam. When pulled down, the headlight is turned to high beam.
- Horn button: When the button is pushed, the horn sounds.
- Turn signal: Push the switch forward for "RIGHT," pull back for "LEFT".
- Decompression lever: When the decompression lever is pulled up, the engine will start.

(5) Make sure that the "kill" switch is "RUN".

The "kill" switch has been equipped to ensure safety in an emergency such as when the motorcycle is brought to a stop and when trouble takes place on the throttle system.

The engine will not start when the "kill" switch is "OFF".

(3) Starter Jet Lever

The XS2 is equipped with a mixture enriching jet built into the carburetor for cold engine starts. Push the lever down to actuate this system. Lift the lever back up as soon as the engine has started and will continue to idle without the rich mixture.

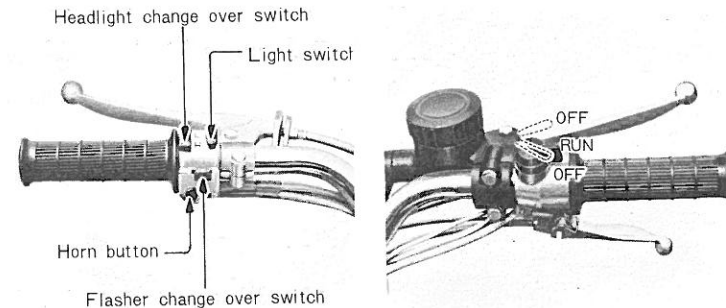
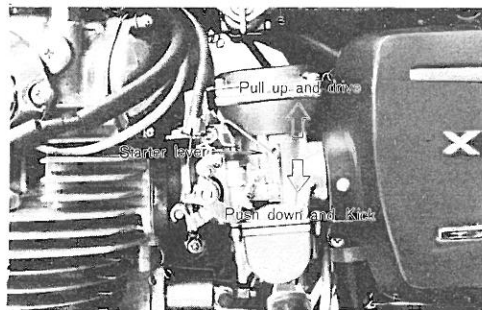

(6) Speedometer

The speedometer is mounted on the front fork bracket to the left of the tachometer. It is driven off the front wheel. There are two odometers mounted within the speedometer face. One registers total mileage while the other is a trip meter.

Trip meter

On the XS2 a trip meter is built into the speedometer shell.

Twist the reset knob gently to reset the trip meter.

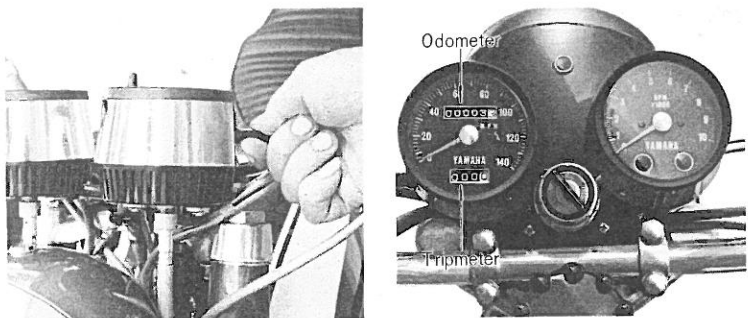

(7) Tachometer

A 0-10,000 rpm tachometer is mounted to the right of the speedometer. The tach is red-lined at 7,500 rpm; do not exceed this red line. The engine was designed to perform best in the 3,000-7,000 rpm range. The tachometer was installed so that it could be used to maintain rpms within this range.

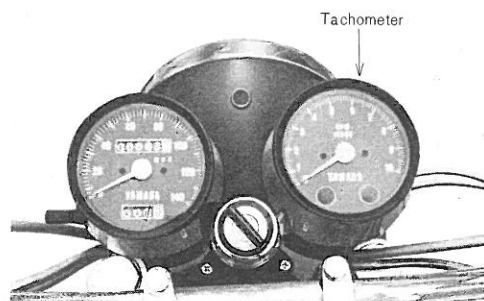

(8) High Beam Indicator

Mounted on top of the headlight shell between the speedometer and tachometer, the high beam indicator lamp glows whenever the headlight high beam is in use.

(9) Neutral Light

Mounted within the tachometer shell, the neutral indicator glows whenever the transmission is in neutral.

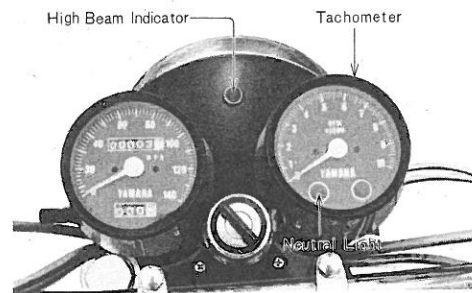

(10) Clutch (Left handle lever)

The left handle lever controls the operation of the clutch.

The clutch itself is of the wet, multi-plate type and is mounted within the right-hand crankcase cover. It is adjustable at two points, one of which is on the lever. Adjustment will be explained later.

(11) Front Brake

The right handle lever controls the operation of the front brake.

On the XS2 the front brake lever has a switch incorporated which operates the stoplight.

(12) Rear Brake

Located on the right-hand side of the machine next to the footpeg the rear brake pedal actuates the single leading shoe rear brake.

(13) Kick Start Lever

Located just above the rear brake pedal is the kick start lever.

The engine can be kick started only in neutral

(14) Shift Lever

On the left-hand side of the engine, just forward of the footpeg is the shift lever. With a slight pressure from the left foot the lever can be moved to select neutral or any one of the five gear ratios within the transmission.

To select neutral, depress the pedal until low gear is engaged and then raise it slightly. The transmission selector mechanism is of the ratcheting type and a firm movement of the foot will automatically select the next lower or higher ratio.

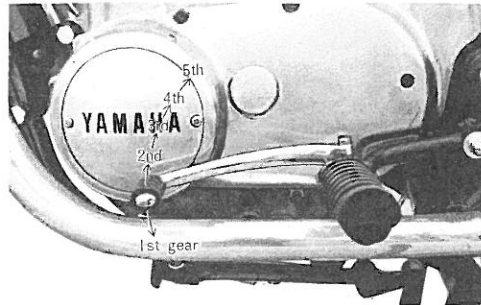

(15) Steering Damper

When driving on rough roads, adjust the steering damper to absorb shock by turning it clockwise.

To get heavier damping, turn the knob clockwise.

To get lighter damping, turn the knob counterclockwise.

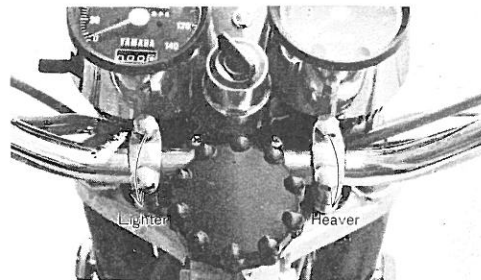

(16) Rear Suspension Unit

The rear suspension units can be adjusted according to load, road conditions, or rider preference.

To adjust the rear units, insert the butt end of one of the screwdriver blades and turn it to change the position of the notched base.

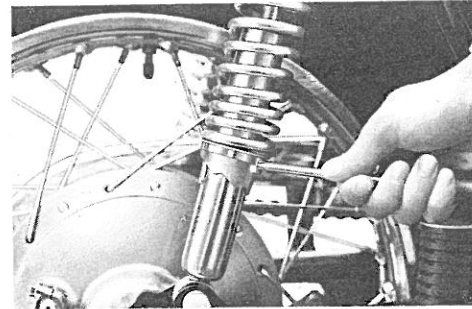

(17) Seat Latch

Located under the left-hand edge of the seat is the release latch. Lift up on the spring loaded arm, pull the wire bracket away from the hook, and raise the seat.

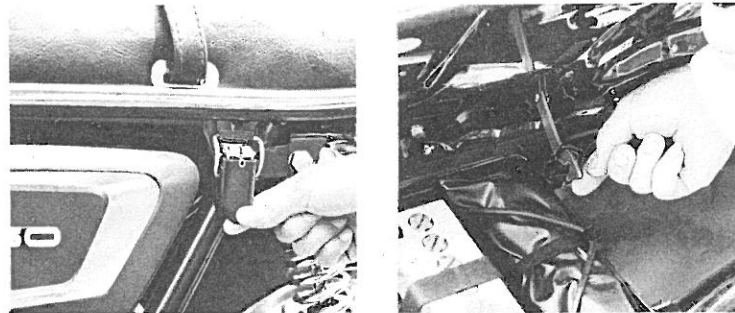

Basic Instructions

(1) Gasoline

Use fuel with an octane rating of 90+. Some regular fuels and most mid-range have 90+ octane ratings. Ethyl (premium) grade fuels usually have octane ratings in excess of 100. In addition, they have considerable tetra-ethyl lead added which can cause spark plug problems. Whenever possible, use fresh, name-brand, regular gasoline of 90-100 octane rating.

(2) Oil

The quality of oil affects the life of the engine and therefore, the oil should be good quality and replaced at specified intervals.

Oil grade: SAE MS or better.

Viscosity: SAE 10W - 30

(3) Checking the Front Brake Fluid

If the brake fluid level becomes low, brake failures will occur, leading to an accident.

Check the mastercylinder for the fluid level. If it is found below the specified level, add the fluid.

Commendable fluid SAE J1703B

Boiling point 240°C

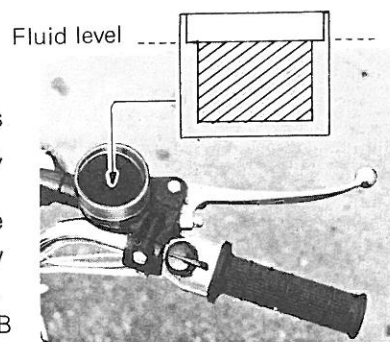

IMPORTANT NOTE

1. To not allow any brake fluid to attach painted surfaces, plastic parts or rubber parts. Or they will be damaged.
2. If the brake fluid is found decreasing rapidly, have your Yamaha dealer check the brake immediately.
3. Avoid using any fluid other than Yamaha commendable fluid.
4. Avoid mixing the brake fluid with other makes. Or chemical reactions may occur, causing brake troubles.
5. When adding the brake fluid, take care not to allow any water to enter.

Operation

(1) Before Starting

A. Fuel

Make sure that you always have enough fuel in the gas tank to get you to your destination. When filling the tank, buy regular grade gasoline with an octane rating of 90 or more.

It is best to not use any gasoline with a high lead content since these cause unwanted deposits. (Many Ethyl gasolines have high quantities of tetra-ethyl lead to raise the octance rating).

B. Checking the engine oil

If the amount of the engine oil is insufficient or the oil is contaminated, moving parts and rotating parts will be quickly worn.

(Refer to "Basic Instructions" and "Servicing.")

C. Checking Tire Pressure

Specified tire pressure: Front-23 lbs/in² (1.6 kg/cm²)

Rear -28 lbs/in² (2.0 kg/cm²)

Note : When you run the machine at a speed of 175 km/h (100+ mph) or more, the tire pressure should be 20 per cent more than the specified.

D. Check the operation of the controls and safety equipment:

- Front and Rear Brakes
- Front brake fluid (See page 16)
- Lights (high and low beams and indicators)
- Throttle
- Stoptlight and switches
- Horn

(2) Starting

1. Insert the key and turn the main switch to the #1 position "Ignition".

2. Turn the fuel petcock to the "On" position.

COLD ENGINE:

3. Push down on the starter jet lever on the carburetor.
Do not open the throttle.

WARM ENGINE:

3. Open the throttle slightly. Do NOT use the starter jet.
4. Unfold the kick pedal lever, engage the kick gear by depressing the pedal until pressure is felt, and kick through or pull up the decompression lever
5. After the engine fires, allow it to warm up for a minute or two. If the starter jet was engaged, raise it back to the off position prior to starting out.

(3) Shifting and Acceleration

Pull in the clutch lever to disengage the clutch. Press down on the toe section of the shift lever to engage first gear. Slowly twist the accelerator grip (engine speed begins to increase) and gently release the clutch lever.

Done properly, the machine will accelerate smoothly.

After starting off, accelerate to approximately 10 mph. Next, to shift into second gear, perform these steps simultaneously:

1. Disengage the clutch while twisting the accelerator grip to the closed position.
2. Shift into second gear by raising the toe section of the shift lever one full position (in this case, the neutral position is bypassed).
3. Increase engine speed slowly and release the clutch lever.
Accelerate to approximately 20 mph. To shift into third gear, repeat the same procedure. Use this procedure each time you want to shift into a higher gear.

You can also use the drag of the engine to slow down. Decelerating is accomplished by reversing the above procedure. Twist the throttle to the closed position, disengage the clutch, and depress the shift lever. Then slowly release the clutch.

Note: When shifting gears always remember that the tachometer is your guide to keep from over-revving and possibly damaging the engine. Keep the rpm's in the 3,000-7,000 rpm range except during break-in, which will be explained later.

(4) Stopping

There are several ways to stop.

Pulling in the clutch lever and twisting the throttle grip in the closed direction will permit you to gradually glide to a stop.

Downshifting through the gears, using the drag of the engine to slow down is another. However, the best method, and the one most universally used, is to use both engine compression (downshifting through the gears as the machine slows) and the front and rear brakes.

When stopping, gradually apply the rear brake while twisting the throttle grip in the closed direction. After the rear brake starts to take hold, gradually apply the front brake.

As the machine continues to slow shift down through the gears using engine compression to aid the slowing effect. When shifting down, watch the tach to see that the engine does not over-rev.

Note: During periods of INCLEMENT WEATHER, I.C., snow, rain, sleet, or ice, or on poor road surfaces where traction is minimal, or in a sharp corner, IT IS NOT ADVISABLE TO FIRMLY APPLY THE FRONT BRAKE. While it is true that the front brake supplies the greater portion of braking power, it is also true that stability can be upset very easily if it is used incautiously under the above conditions.

(5) Cruising

A frequently asked question is "What rpm should I cruise at?". The BREAK-IN section provides limitations when the motorcycle is new, but once the engine has been broken in, then we suggest that you follow these guide lines. For sustained load and throttle conditions, such as those encountered on open highways, cruise at 3/4 throttle or at 3/4 of the rpm "red line" whichever comes first. Always bear in mind though, the maximum allowable speed limit for the area through which you are riding. This is a recommendation, not a "hard and fast" rule. Any modification or personalization of the running gear could possibly change the operating range most comfortable and most efficient for the engine.

Maintenance (Trips):

Prior to starting out on a major trip, or at intervals of one month or 1,000 miles, all of the fittings on the motorcycle should be checked for tightness. These include:

1. Chain adjust bolt lock nuts.
2. Headlamp, front fork and front axle nuts.
3. Speedometer and tachometer fittings.
4. Carburetor clamp screws.
5. Side cover and air cleaner securing screws.
6. Engine mounting bolts.
7. Foot peg and exhaust system securing bolts.
8. Crankcase cover Allen screws.
9. Rear axle securing nut.
10. Front and rear fender mounting bolts.
11. Taillight and license plate mounting bolts.

NOTE: The fittings on your XS2 which are subjected to vibration are either rubber mounted or secured with self-locking aircraft type nuts and therefore should not be affected by vibration. However, it is a good safety point to always check your machine in any case.

TORQUE: All fittings require a minimal amount of torque during tightening to keep them from vibrating loose. Excessive tightening will only lead to stripped threads and broken studs.

As a rule of thumb, use the following tightening chart:

STUD SIZE	TORQUE
6 mm	90 in/lbs.
7 mm	135 in/lbs.
8 mm	180 in/lbs.
10 mm	300-350 in/lbs.
12 mm	350-400 in/lbs.
14 mm	400-450 in/lbs.
Axle Nuts	500-600 in/lbs.

Break-in

THERE IS NEVER A MORE IMPORTANT PERIOD IN THE LIFE OF YOUR XS2 THAN THE PERIOD BETWEEN ZERO AND FIVE HUNDRED MILES'

For this reason we ask that you carefully read the following material.

Because the engine is brand new, you must not put an excessive load on it during the first several hours of running. You could look it in this manner: During the first 500 miles the various parts in the engine wear and polish themselves to the correct operating clearances. During this period prolonged full throttle operation, or any condition which might result in excessive head and cylinder temperatures, must be avoided. However, momentary full throttle operation under load (two seconds maximum) does not harm the engine. Each full throttle acceleration sequence should be followed with a substantial "rest period" for the engine by cruising at lower rpm's so the engine can rid itself of the temporary build up of heat.

The method for breaking in an XS2 is quite simple.

1. Zero to 300 fifty miles: Avoid operation above 3,500 rpm. Allow a cooling off period of five to ten minutes after every hour of operation. Vary the speed of the motorcycle from time to time. Do not operate it at one, set, throttle position.
2. 300 to 600 miles: Avoid prolonged operation above 4,000 rpm. Allow the motorcycle to rev freely through the gears but do not use full throttle at any time.
3. 600 miles and beyond: Avoid prolonged full throttle operation. Avoid cruising speeds in excess of 7,000 rpm's. Vary speeds occasionally.

Inspection and Service

This chart should be considered strictly as a guide to general lubrication and maintenance periods. You must take into consideration that weather, terrain, geographical locations, and a variety of individual uses all tend to demand that each owner alter this time schedule to match his environment. If the motorcycle is continually operated in an area of high humidity, then all parts must be lubricated more frequently than shown on the chart to avoid the ravages of water on metal parts. If you are in doubt as to how closely you can follow these time recommendations, check with the dealer in your area.

Greasing and Oiling

			300 miles	1,000 miles	2,000 miles	every 2,000 miles	every 4,000 miles
1	Brake cam shaft	G		○	○	○	
2	Wheel bearing	G			○		○
3	Clutch wire	M/O		○	○	○	
4	Tacho, speedometer cable	M/O			○	○	
5	Meter gear unit	G			○	○	
6	Steering ball race	G					○
7	Front fork oil	M/O	○		○	○	
8	Brake pedal shaft	G		○	○	○	
9	Change pedal shaft	M/O,G			○	○	
10	Axle grip	G		○	○	○	
11	Engine oil	M/O	○	○	○	○	
12	Dynamo lubricator	G					○
13	Stand shaft	M/O,G					○
14	Rear arm pivot shaft	G			○	○	
15	Drive chain	M/O		○	○	○	

Check Point Periodic Inspection Guide

		Pre-operation check	300 miles	1,000 miles	2,000 miles	every 2,000 miles	every 4,000 miles
1	Checking the brake fluid	○	○	○	○	○	
2	Front and rear brake adjustment (F.R)	○	○	○	○	○	
3	Clutch adjustment		○	○	○	○	
4	Engine oil replacement	○	○	○	○	○	
5	Front fork oil replacement		○		○	○	
6	Grease up			○	○	○	
7	Battery electrolyte refilling	○	○	○	○	○	
8	Spark plug cleaning	○	○	○	○	○	
9	Ignition timing adjustment			○	○	○	
10	Fuel pet cock cleaning		○	○	○	○	
11	Carburetor adjustment			○	○	○	
12	Carburetor cleaning						○
13	Air cleaner cleaning	○		○	○	○	
14	Cylinder, piston cleaning			○		○	
15	Drive chain adjustment, oiling		○	○	○	○	
16	Bolt, Nut retightening		○	○	○	○	
17	Spoke, Rim inspection			○	○	○	
18	Oil filter element cleaning					○	
19	Tappet clearance adjustment					○	
20	Cam chain adjustment					○	

Be sure to check the above points before long-distance touring.

SERVICING

CLUTCH CABLE:

The clutch cable requires periodic lubrication to prevent the cable strands from rusting or hanging up in the casing. First, disconnect the cable from the clutch lever by screwing the adjuster all the way back to the cable casing. This will provide enough free play in the cable for you to slip the cable out of the lever holder through the slot in the lock nut, adjuster, and holder. Hold the cable upright and allow several drops of liquid graphite to flow down the cable.

Hold the cable upright for several minutes to permit complete lubrication.

If the cable needs to be replaced, then perform the steps above and disconnect the cable at the lever. Next, disconnect the cable at the engine. Begin by taking off the cover that houses the clutch activating mechanism (left side of the engine). Looking at the inside of this cover, you will see the clutch actuating arm. Push the arm up and lift the cable end off. Removing the old cable and hooking up the new one will take but a few moments.

CLUTCH CABLE ADJUSTMENT:

The XS2, has two clutch adjustments. The first, located at the handlebar clutch lever, is used to take up slack from cable stretch and to provide sufficient free play so that the clutch engages and disengages completely. The picture below illustrates all the parts involved in making the adjustment.

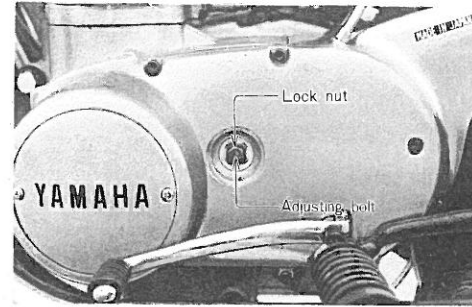
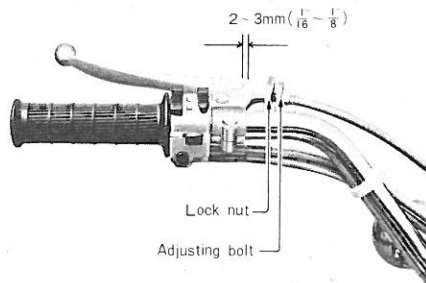

1. First, loosen the locknut at the lever. Then turn the adjuster either in or out depending on which direction is necessary to arrive at 2-3 mm (1/16"-1/8") free play.
2. The second adjustment is located behind the clutch adjustor, cover. Removing the cover will expose the adjusting set screw and lock nut. Loosen the lock nut, rotate the set screw in until it lightly seats against a clutch push rod that works with the set screw to operate the clutch. Back the set screw out 1/4 turn and tighten the lock nut. This adjustment must be checked because heat and clutch wear will affect this free play, possibly enough to cause incomplete clutch operation.

Front Brake Adjustment

The front brake lever should be so adjusted that it has a free play of 13-26mm from when the brake lever is pooled to when the brake begins to be effected.

1. Loosen the adjust screw lock nut.
2. By turning in and out the adjust screw, adjust the play of the brake lever and then lock it with the lock nut.

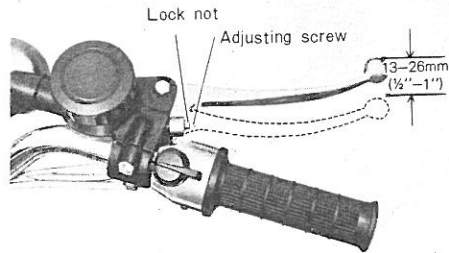

Rear Brake

The correct free play of the rear brake pedal is about 1.0 in. (25 mm.). Adjust by turning the adjusting nut at the end of the rear brake rod a half turn at a time. After adjusting the brake, make sure the Stoplight is working. If not, readjust the stoplight switch.

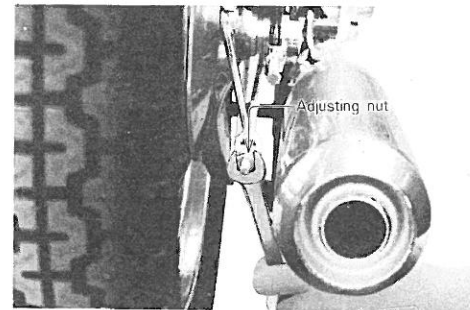
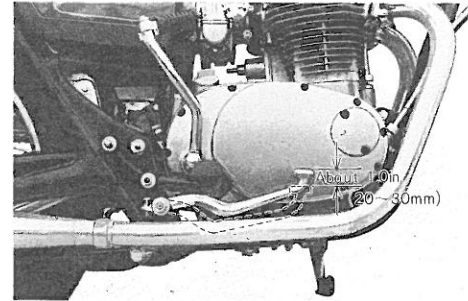

Note: Inspect the brake linings for wear and clean the brake shoes and drums every 2,000 miles (3,000 km). Always keep the shoes and drums free of oil.

THROTTLE CABLE AND GRIP LUBRICATION:

The throttle twist grip assembly should be greased at the time that the cable is lubricated, since the grip must be removed to get at the end of the throttle cable. Two screws clamp the throttle grip to the handlebar. Once these two are removed, the end of the cable can be held high to pour in several drops of liquid graphite. Coat the metal surfaces of the grip assembly with a suitable all-purpose grease to cut down friction.

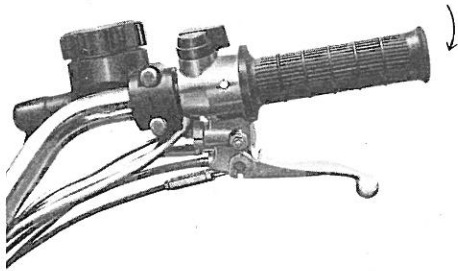

Checking the throttle valves for synchronization and full throttle:

To check the throttle valve at full throttle, fully turn out the throttle grip, and make sure that the valve is in the full open position. If the throttle lever is in contact with the shaft on which the throttle valve return spring is hooked as shown in the drawing below the opening of the throttle valve at "full open" is correct. Next, turn out the throttle grip slightly, and check to see whether or not both right and left throttle levers begin to move simultaneously. If not, the throttle levers should be corrected by use of the throttle wire adjuster.

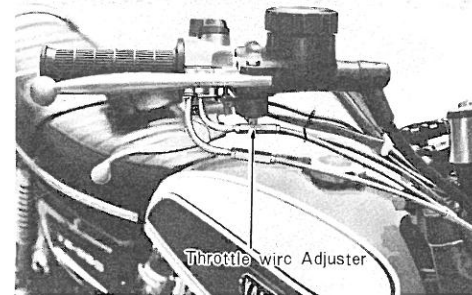
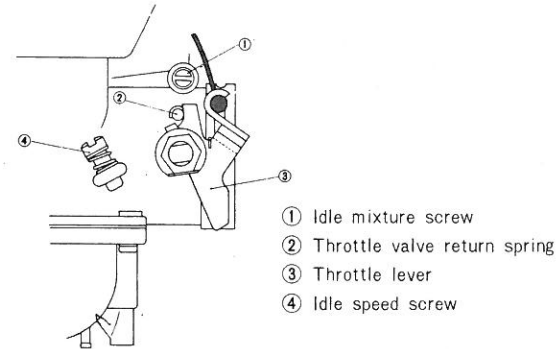

Headlight

To replace the headlight bulb, remove the two countersunk screws (Phillips) from the lower part of the headlight body. Remove the head lamp rim from the headlight body, and remove the sealed beam unit can then be removed for replacement.

There are two headlight beam adjusting methods. To adjust the headlight beam horizontally, turn in or out the slot-head screw on the head lamp rim. To adjust it vertically, loosen the head lamp mounting bolts on the bottom of the shell and tilt the head lamp body.

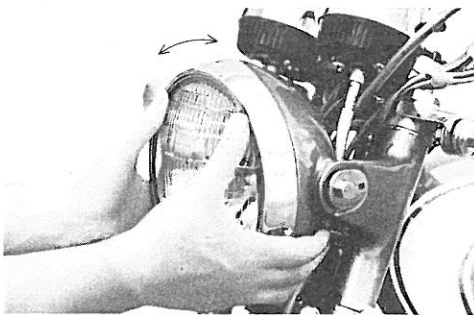
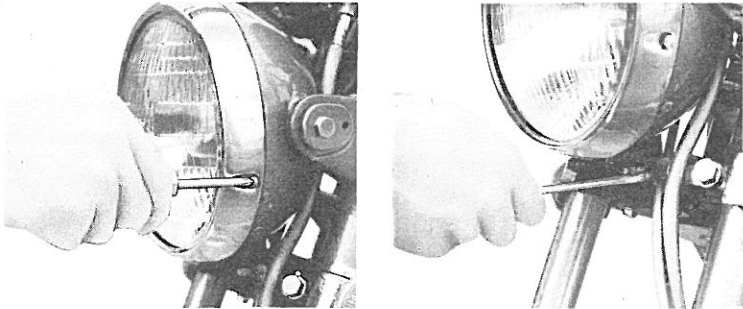

Drive chain:

Because the chain consists of an extraordinary amount of parts that rub against one another, it is prone to wear if it is not maintained constantly and correctly. Without any lubrication, a chain can wear out within 500 miles. You should develop a habit of servicing the chain on a regular schedule. This habit is especially important if you spend the major portion of your time riding in the dirt where dust and dirt can readily work into the chain links.

1. Lubrication — there are several excellent pressure can lubricants available. Use a rag to wipe off any accumulation of dirt, then spray a liberal amount of lubricant on the chain (See page 22)
2. Cleaning — the chain has to be periodically removed from the machine and soaked in cleaning solvent. Completely saturate the chain with solvent to remove as much dirt as possible. Drain and dry the chain thoroughly. Immediately after the chain has dried completely, lubricate to prevent any rust from forming.
3. Adjustment — proper drive chain up and down free play, with the rider in position and both wheels on the ground, should equal 20 mm (3/4") when measured at the center of the lower section of chain.

Follow these steps to obtain the correct free play:

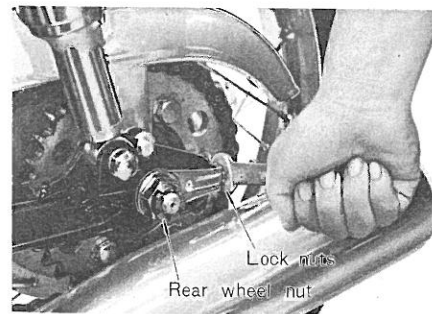

- a. Loosen the rear wheel nut
- b. Loosen the chain adjusting bolt lock nuts
- c. Rotate the adjusting bolts in or out, whichever is needed to obtain the correct free play, and at the same time make sure that both ends of the axle are positioned evenly. This can be checked by utilizing the marks on the very end of the swing arms, just above and to the rear of the rear wheel must.
- f. After completing the adjustment, retighten all the lock nuts.
- g. Finally, check for correct brake pedal operation as it could have changed due to the chain adjustment.

4. Checking the chain

Whenever you have the chain off for cleaning, take time to check for excessive wear or links binding up. Clean the chain first and hold the chain straight up in the air. Visually check to see if any part of the chain is kinked (any place the chain does not hang straight down).

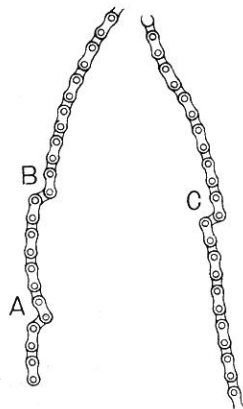

Another check is to lay the chain on a bench, in a straight line, and see how much the chain "bows".

A new chain, or one that can still be used, will not deviate more than 3" - 4" from a straight line.

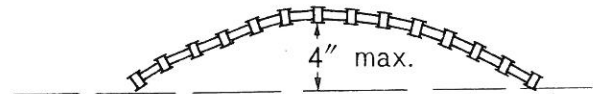

A simple test that can be utilized while the chain is still on the motorcycle is to lift the chain away from the curvature of the rear wheel sprocket. A chain is defective if you can pull the chain away from the sprocket more than half the length of a chain link.

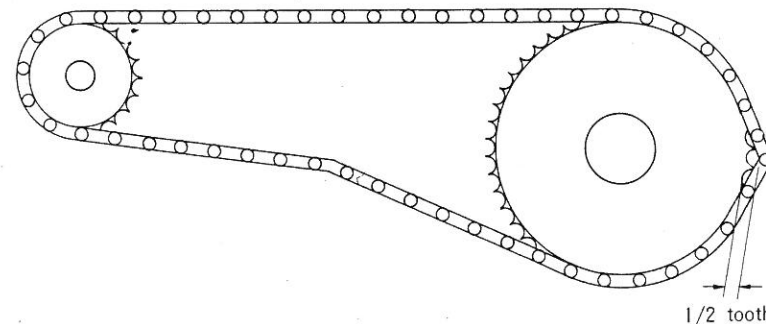

Note: Whenever reinstalling the chain, always install the master link retaining clip so that the rounded end faces the direction of travel.

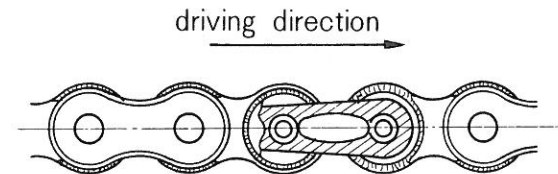

Note: TO DETERMINE THE VALUE OF KEEPING THE CHAIN IN PROPER WORKING CONDITION, JUST CONSIDER THAT A CHAIN THAT HAS BECOME EXCESSIVELY WORN COULD QUITE POSSIBLY REDUCE THE LIFE OF BOTH SPROCKETS. WHENEVER YOU INSTALL A NEW CHAIN, ALWAYS CHECK BOTH SPROCKETS. IF EITHER ONE IS WORN SUFFICIENTLY, REPLACE IT. BEAR IN MIND THAT A WORN SPROCKET CAN POSSIBLY CAUSE YOUR BRAND NEW CHAIN TO WEAR

OUT PREMATURELY.

Battery:

The life of your battery depends greatly on how well you keep it serviced. In order to service it completely and correctly, there are certain facts that you must know.

1. Always keep the battery fluid level between the "Maximum" and the "Minimum" level. It should be checked at least once a month, and more often during hot weather. If the battery needs filling, use distilled water. Do not use tap water as it usually contains minerals that can be harmful to the life of the battery.

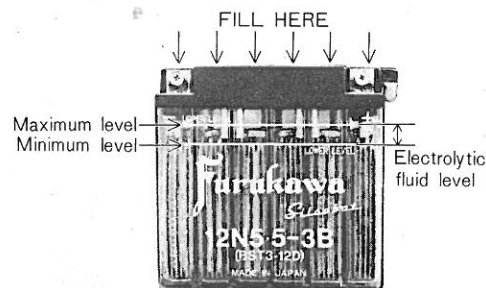

2. If for any reason the battery has become discharged, and you are going to charge it yourself, use a "trickle charger" that has no more than a one amp per hour rating. Also, make sure that all the battery caps have been taken off and that the rubber battery breather tube is not clogged or pinched shut. A charging battery creates gas, and pressure could build up in the battery if all the outlets were plugged up.

- If the motorcycle is to be stored for more than a month, then remove the battery, have it fully charged, and store it in a cool dry storage area. If storage time is going to be lengthy, it is best to leave the battery with your dealer with specific instructions to recharge the battery every month or so. This procedure is necessary to insure maximum battery life.
- When reinstalling the battery, be sure to hook up the RED lead to the positive terminal and the BLACK lead to the negative terminal (the polarity of each is stamped just below each terminal).

Carburetor

There are only two adjustments on the carburetor that do not require the services of a mechanic: the idle mixture and the engine idle speed. Because the carburetor is such a critical part of the engine, any carburetor disassembly should be done by an experienced mechanic.

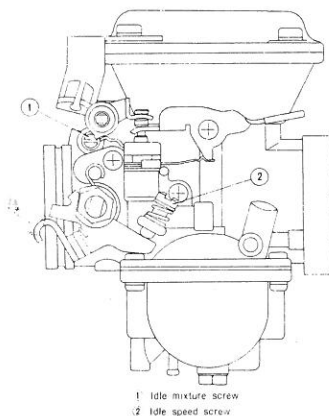

This picture shows the location of the two adjustments. To set the idle mixture you must turn the idle mixture screw (1) in until lightly seated, then back it out 3/4 turn — no more or no less. DO NOT EXPERIMENT. This is a factory setting that can be set with the engine stopped and no further adjustment is required.

Engine idle speed is set by warming up the engine completely and then screwing the idle speed screw (2) in or out, whichever direction is necessary for the engine to idle between 900 and 1,000 rpm.

Air Filter

The air filter element should be removed and cleaned once a month.

- Remove the side cover.

(See page 23)



- Remove the air cleaner element.

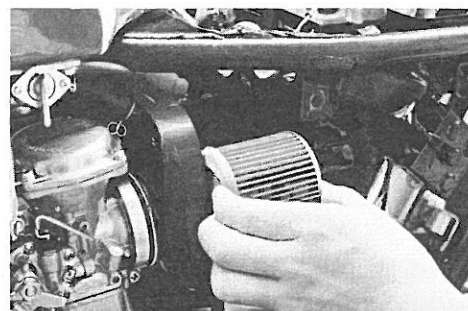

- Remove the dust from the air cleaner element by tapping it lightly, and clean it with compressed air.

Ignition timing

Timing is of critical importance. If, after both your service check-ups have been completed, and for any reason you wish to check the timing, have your dealer check for you.

Breaker Points

The ignition breaker points greatly affect ignition.

It is necessary, therefore, that the points be periodically polished with oil stone or sandpaper and that the point gap be correctly adjusted. If the adjustment is made wrong, the ignition timing will be incorrect. It is advisable to have the point gap adjusted by a Yamaha dealer.

Breaker point gap: 0.3 – 0.4 mm

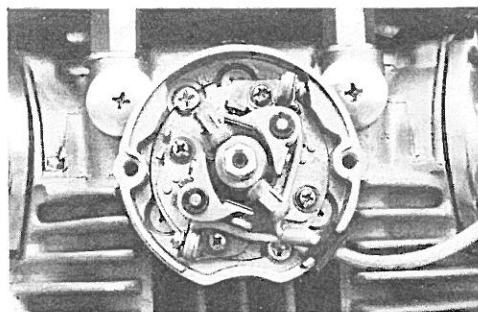

Spark plug:

The spark plug in your machine can tell you a great deal as to how the engine is operating when you know how to "read" the plug. If the engine is operating correctly, and if it is being ridden correctly, then the tip of the white insulator in the spark plug will be a light tan color (standard plug is NGK B7ES). If, when you remove the spark plug, it is very dark brown or black, then a plug with a hotter heat range is needed. This situation is quite common during the engine break-in period. If the insulator tip shows a very light tan color, or is actually white, or if the electrodes begin to melt, then a spark plug with a colder heat range is required. Again, if the spark plug insulator tip does not have a light tan color, have your dealer install a spark plug with a different heat range to correct the situation. Do not attempt to experiment with different heat range spark plugs yourself, as it takes an experienced eye to gauge which spark plug to use.

It is all right though for you to replace the standard plug.

Engine conditions can cause any spark plug to slowly break down. If deposits begin to build up, or if the electrodes finally become too worn, or if for any reason you believe the spark plug to not be functioning correctly, replace it. Be sure, when replacing the plug, that you always clean the gasket surface, that you use a new gasket, and that the spark plug is torqued to 20-25 ft/lbs. Also wipe off any grime that might be present on the surface of the spark plug.

The plug can be taken out to be cleaned and gapped. As long as deposit built-up on the insulator is not extreme, you can use a spark plug cleaner to quickly remove the deposits.

Use a wire type feeler gauge to set the electrode gap at 0.024"-0.028" (0.6mm - 0.7mm).

Engine Oil

The engine oil is used to lubricate the cylinder, piston, crankshaft, transmission, clutch, etc.,. If these parts lack lubrication or the oil is dirty, moving parts and rotating parts will be quickly worn, thus shortening their service life.

Recommended oil: Motor oil SAE MS or better quality

Viscosity: SAE 10W - 30

Amount of oil: 2.5 liters

Replacement: After first 300 miles or first month.

Thereafter: Every 2,000 miles or 6 months.

(See page 22)

To check the level, warm the engine up for several minutes, screw the dip stick completely out and then just rest the stick in the hole.

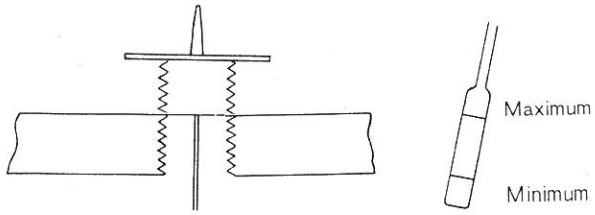

The dip stick has a Minimum and a Maximum mark, and the oil level should be between the two. If the level is lower, then add sufficient oil to raise it to the proper level.

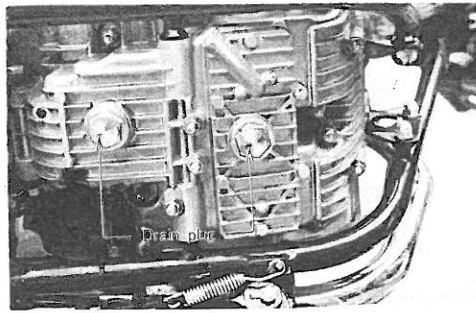

Oil Filter Element

The oil filter element must be cleaned whenever the oil is replaced every 2,000 miles of travel.

How to clean

- 1) Remove the oil filter cover To remove it, remove the two bolts from the cover by use of the hexagon nut wrench (service tool).
- 2) Remove the securing bolt with a box wrench (service tool) and take out the oil filter element.
- 3) Wash the oil filter element with gasoline and blow with compressed air to clean it.

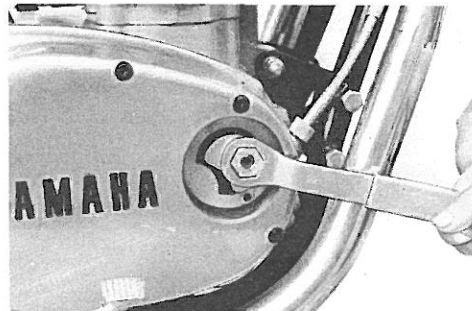
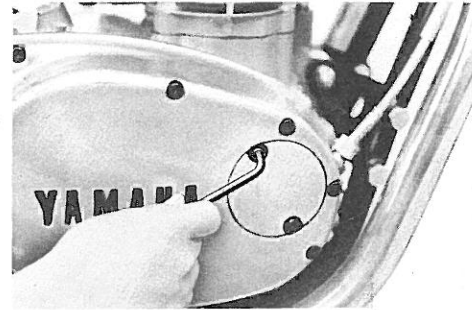

Note: When installing the cover, take care not to damage the "O" ring of the oil seal.

There is also an oil screen in the engine sump. This should be removed and cleaned by your dealer every 4,000 miles.

Steering:

Periodically you should check for any looseness in the steering assembly. Do this by blocking the front end off the ground, grasping the bottom of the forks, and gently rocking the fork assembly backward and forward. You will feel any looseness in the steering assembly bearings. If any exists, do not attempt to correct it yourself but let your dealer make the adjustment with the correct tools.

Also, these same front fork bearings must be lubricated every 3,000 miles. This the dealer must also do.

Rear suspension units:

These are sealed units and maintenance is not possible. They are adjustable though, for your personal riding comfort. There are three adjustments, each with progressively increasing stiffness.

Insert the butt end of the tool kit screwdriver into the notched spring stop and rotate it to the position most suitable for you.

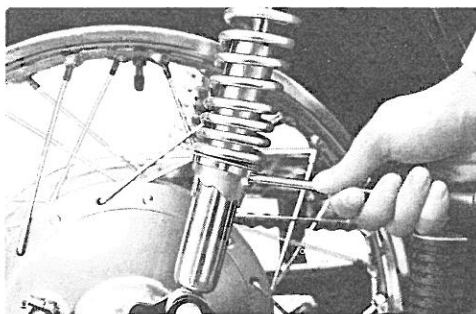

Adjusting Tapper (VALVE) Clearance

The tappet clearance is one of the most important factors in increasing the life of the engine.

Any incorrect clearance will cause noise and adversely affect the operating condition of the engine. The tappet clearance should be checked and adjusted every 2,000 miles of travel. Have it adjusted by a Yamaha dealer.

Adjustment (Engine cold)

1. Remove the four tappet covers from the cylinder head.
2. Remove the dynamo cover.
3. Turn the crankshaft and match the mark on the rotor with the T mark on the stator so that one of the two cylinders will reach T.D.C. of the compression stroke.

In this case, the other piston is at T.D.C. of the exhaust stroke.

After the first adjustment, turn the crankshaft 360°, and then the other piston will be at T.D.C. of the compression stroke.

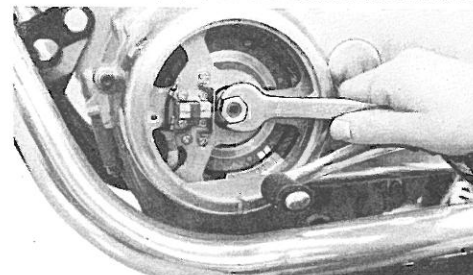

Match marks

T T.D.C.

F Fire

To check which side piston is at T.D.C. of the compression stroke, place your finger in the plug hole of one cylinder head, and turn the crankshaft, then making sure that the marks are matched.

When the cams do not raise the rocker arms, both for intake and exhaust, the piston of the cylinder is at T.D.C. of the compression

stroke. (When the piston is at T.D.C. of the exhaust stroke, both intake and exhaust valves are closed)

4. Adjust the tappet clearance.

The tappet clearance should be adjusted to 0.15 mm for intake and 0.20 mm for exhaust. For this adjustment, measure the clearance between the valve stem and the rocker arm adjustment screw with a thickness gauge.

Inlet	0.15mm (0.006")	engine cold
Exhaust	0.20mm (0.008")	

Loosen the rocker arm's lock nut, and turn in or out on the adjustment screw to adjust the clearance. When the clearance is correctly adjusted, tighten the lock nut.

Tightening — Clearance becomes smaller.

Loosening — Clearance becomes larger.

Both intake and exhaust tappet clearances can be adjusted in the same manner. After the adjustment, turn the crankshaft 360° and adjust the other cylinder's tappet clearance.

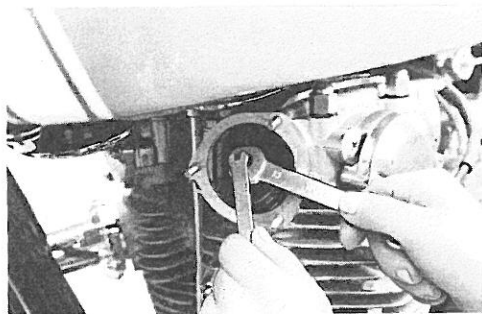

Note: Tighten the lock nut, and make sure that the tappet clearance is correct.

Fully tighten the lock nut so that it will not become loose.

Tightening torque: 2.5 kg-m (18.1 ft/lbs.)

Adjusting the cam chain (Engine cold)

The cam chain is most easily adjusted by your dealer. However, if this is not possible, the cam chain can be adjusted in the following manner:

1. Rotate the crankshaft in a counterclockwise direction (from the left side of the engine) to place all chain slack in the area of the chain tensioner.
2. The chain tensioner is located between the two cylinders just below the carburetors. Remove the cast metal cover.
3. Loosen the tensioner lock nut.
4. Use a wrench to turn the adjuster in until the flat end of the push rod is flush with the end of the adjuster.
5. Tighten the lock nut and re-install the cover.
6. This adjustment should be checked every 2,000 miles.

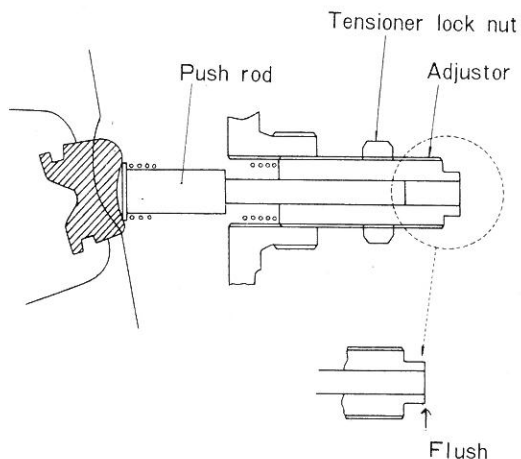

Stopping Distance

This figure indicates braking performance that can be met or exceeded by the vehicles to which it applies, without locking the wheels, under different conditions of loading and with partial failures of the braking system. The information presented represents results obtainable by skilled drivers under controlled road and vehicle conditions, and the information may not be correct under other conditions.

Description of vehicles to which this table applies: Yamaha motorcycle XS2

A. Fully Operational Service Brake

Load

Light

Maximum

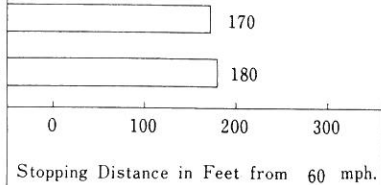

Acceleration and passing ability

This figure indicates passing times and distances that can be met or exceeded by the vehicles to which it applies, in the situations diagrammed below.

The low-speed pass assumes an initial speed of 20 mph and a limiting speed of 35 mph. The high-speed pass assumes an initial speed of 50 mph and a limiting speed of 80 mph.

NOTICE: The information presented represents results obtainable by skilled drivers under controlled road and vehicle conditions, and the information may not be correct under other conditions.

Description of vehicles to which this table applies: Yamaha motorcycle XS2

Summary table:

Low-speed pass..... 335 feet; 6.6 seconds

High-speed pass..... 850 feet; 8.1 seconds

LOW-SPEED

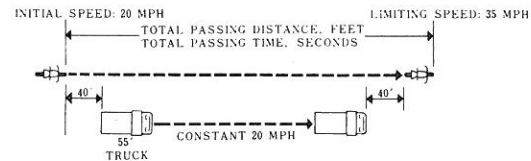

HIGH-SPEED

