

## General Specifications

	XS360	XS400D	XS400E	XS400-2E	XS400F/2F	XS400G/SG,H
<b>Engine</b>						
Type	air cooled, SOHC twin	air cooled, SOHC twin	air cooled, SOHC twin	air cooled, SOHC twin	air cooled, SOHC twin	air cooled, SOHC twin
Displacement (cc/ci)	358/21.6	392/23.9	392/23.9	392/23.9	392/23.9	392/23.9
Bore x Stroke (mm/in.)	66.0 x 52.4/2.53 x 2.06	69.0 x 52.4/2.72 x 2.06	69.0 x 52.4/2.72 x 2.06	69.0 x 52.4/2.72 x 2.06	69.0 x 52.4/2.72 x 2.06	69.0 x 52.4/2.72 x 2.06
Compression ratio	8.7 : 1	9.2 : 1	9.3 : 1	9.4 : 1	9.3 : 1	9.3 : 1
Starting system	①	①	①	①	①	①
Ignition system	battery and coil	battery and coil	battery and coil	battery and coil	battery and coil	battery and coil
Lubrication system	wet sump	wet sump	wet sump	wet sump	wet sump	wet sump
Carburetion	Mikuni BS34	Mikuni BS34	Mikuni BS34	Mikuni BS34	Mikuni BS34	Mikuni BS34
<b>Transmission</b>						
Clutch type	wet, multi-plate	wet, multi-plate	wet, multi-plate	wet, multi-plate	wet, multi-plate	wet, multi-plate
No. speeds	6	6	6	6	6	6
Primary reduction	78/24 (3.250)	78/24 (3.250)	78/24 (3.250)	78/24 (3.250)	78/24 (3.250)	78/24 (3.250)
Secondary reduction	40/16 (2.500)	37/16 (2.312)	37/16 (2.312)	37/16 (2.312)	37/16 (2.312)	38/16 (2.312)
<b>Gear ratios</b>						
1st	35/14 (2.500)	35/14 (2.500)	35/14 (2.500)	35/14 (2.500)	35/14 (2.500)	35/14 (2.500)
2d	32/18 (1.777)	32/18 (1.777)	32/18 (1.777)	32/18 (1.777)	32/18 (1.777)	32/18 (1.777)
3rd	29/21 (1.380)	29/21 (1.380)	29/21 (1.380)	29/21 (1.380)	29/21 (1.380)	29/21 (1.380)
4th	27/24 (1.125)	27/24 (1.125)	27/24 (1.125)	27/24 (1.125)	27/24 (1.125)	27/24 (1.125)
5th	25/26 (0.961)	25/26 (0.961)	25/26 (0.961)	25/26 (0.961)	25/26 (0.961)	25/26 (0.961)
6th	26/30 (0.866)	26/30 (0.866)	26/30 (0.866)	26/30 (0.866)	26/30 (0.866)	26/30 (0.866)
<b>Chassis</b>						
Frame	semi-double cradle	semi-double cradle	semi-double cradle	semi-double cradle	semi-double cradle	semi-double cradle
Caster	26° 30'	26° 30'	27°	26° 30'	27°	27° 30'
Trail (mm/in.)	81/3.2	85/3.4	84/3.3	81/3.2	84/3.3	87/3.4
Front suspension	telescopic fork	telescopic fork	telescopic fork	telescopic fork	telescopic fork	telescopic fork
Rear suspension	swing arm/shock absorber	swing arm/shock absorber	swing arm/shock absorber	swing arm/shock absorber	swing arm/shock absorber	swing arm/shock absorber
<b>Tire size</b>						
front	3.00 x 18	3.50 x 18	3.00 x 18	3.00 x 18	3.00 x 18	3.00 x 18 (tubeless)
rear	3.50 x 18	3.50 x 18	3.50 x 18	3.50 x 18	3.50 x 18	120/90-16 63S (tubeless)
<b>Fuel capacity (gal/l)</b>						
	2.9/11	2.9/11	3.7/14	2.9/11	3.7/14	3.7/14
<b>Overall Dimensions</b>						
Length (mm/in.)	2045/80.5	2025/79.7	2065/81.2	2025/79.5	2065/81.2	2065/81.2
Width (mm/in.)	845/33.3	845/33.3	865/34.1	845/33.3	845/33.3	845/33.3
Height (mm/in.)	1100/43.3	1100/43.3	1140/44.9	1100/43.3	1100/43.3	1100/43.3
Seat Height (mm/in.)	800/31.5	815/32.1	780/30.7	815/32.1	815/32.1	770/30.3
Ground clearance (mm/in.)	155/6.1	150/5.9	150/5.9	150/5.9	150/5.9	135/5.3
Dry Weight (kg/lbs)	②	164/367	168/370	155/342	②	②

① XS360C: electric and kick  
XS360-2D: kick  
② XS360C: 159/350  
XS360-2D: 153/337  
③ XS400F: electric and kick  
XS400-2F: kick

④ XS400F: 865/34.1  
XS400-2F: 845/33.3  
⑤ XS400F: 1140/44.9  
XS400-2F: 1130/44.5  
⑥ XS400F: 168/370  
XS400-2F: 159/351

⑦ XS400G: 860/33.9  
XS400SG: 870/34.3  
XS400H: 860/33.9  
⑧ XS400G: 1105/43.5  
XS400SG: 1140/44.9  
XS400H: 1105/43.5

⑨ XS400G: 166/366  
XS400SG: 169/373  
XS400H: 167/366

## SERIAL NUMBER LOCATION

In order to prevent possible confusion when ordering parts, always refer to the engine and frame serial numbers.

The frame number is stamped on the right side of the steering lug, while the engine number is located on a raised boss just behind the right cylinder on the top of the crankcases.

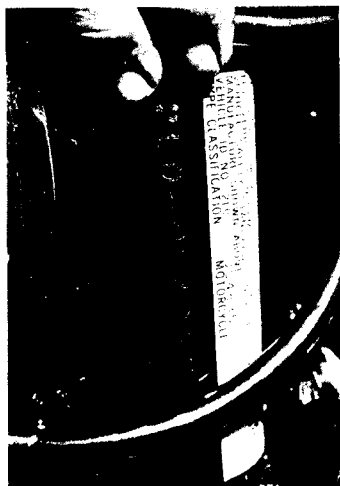

Frame serial number location

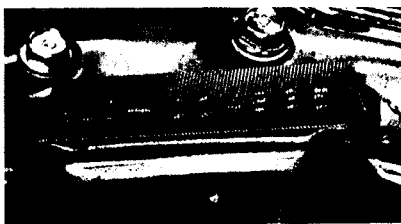

Engine serial number location

## MAINTENANCE

NOTE: Common maintenance procedures are explained in detail in "General Information."

### LUBRICATION

#### Motor Oil

When the average air temperature is above 5° C (41° F), use Yamalube 4-stroke oil, or SAE 20W-40, service rating "SE," or "SF."

When the air temperature is consistently below 15° C (59° F), use SAE 10W-30, service rating "SE" or "SF."

Straight grades can also be used according to ambient air temperatures as given in the

"Recommended Lubricants" chart at the end of this section.



Maintain the oil level between the upper and lower dipstick marks (A and B)

### Checking Oil Level XS400G/SG-ON

1. A sight glass in the crankcase is provided to enable the rider to check oil level at a glance. When checking, the motorcycle should be parked on the centerstand on a level surface.

# Yamaha XS360-400

2. Oil should be checked when the engine is warm. After shutting it off, let the machine sit for a few minutes.

3. Maintain the oil level between the

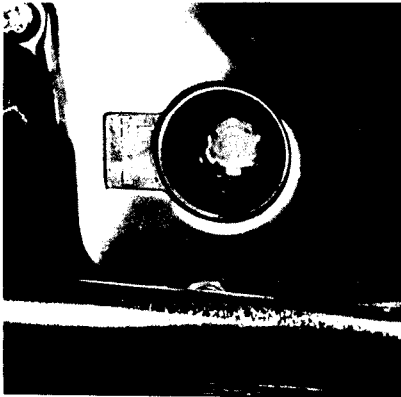

Oil level sight glass

upper and lower level marks inscribed on the crankcase. If the oil level is too low, remove the filler cap and add enough oil to bring the level up to the upper level mark. Do not overfill.

## OTHER MODELS

1. A dipstick is provided to check the oil level.

2. The motorcycle should be parked on level ground and put on the centerstand.

3. Unscrew and remove the dipstick and wipe it off. Reinsert the dipstick, allowing it to rest on the treads of the hole. Oil level should be between the maximum and minimum marks on the stick. If the oil level is too low, add enough oil to bring the level up to between the marks. Do not overfill the crankcase.

## Changing Oil

1. The recommended oil change interval is 2,000 miles or every 3 months, whichever comes first.

2. Oil should be changed when the engine is warm. This ensures more complete draining and makes it more likely that the oil will carry off any particulate matter with it.

3. Remove the dipstick. Place a suitable container (at least 2½ qt. capacity) beneath the engine and remove the drain plug. Allow the oil to drain off for several minutes, then install the drain plug and tighten it securely. Proper torque is 25–29 ft lbs.

4. Remove the oil filter screen and the oil filter if it is time to service them (see below).

5. Add 2.1 qts. (2.0 l) of the recommended grade and viscosity oil to the crankcase. If the filter has been changed, add 2.4 qts. (2.3 l).

6. Start the engine and let it run for a few minutes. Then shut it off and check the oil level with the dipstick. Add additional oil, if necessary, to bring the level to between the level marks on the dipstick.

## Oil Filter

1. The disposable oil filter element should be replaced at every other oil change: 4,000

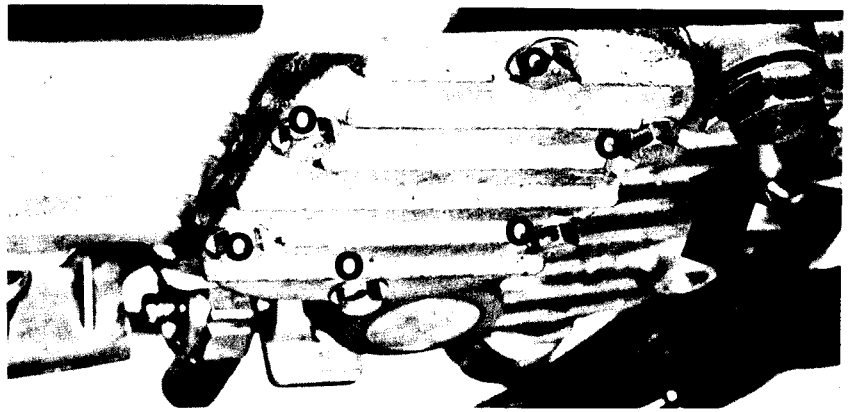

Crankcase drain plug (arrow). Filter screen bolts (0)

miles or every 6 months, whichever comes first.

2. Drain the oil as outlined above.

3. Remove the oil filter housing bolt and remove the housing and filter element. Have a container placed beneath the filter housing prior to removal to catch any oil which might drip out.

4. Clean the inside of the filter housing prior to fitting a new filter element.

5. Install the new element and refit the housing. Tighten the housing bolt to 10–12 ft lbs. *Do not overtighten.*

6. Fill the crankcase with 2.4 qts. (2.3 l) of the recommended grade and viscosity oil.

7. Run the engine for several minutes and check for leaks.

## Filter Screen

1. The XS360 and XS400 are fitted with an oil filter screen in the sump. The screen should be removed and cleaned every other time the oil is changed: every 4,000 miles or 6 months, whichever comes first.

2. Drain the oil as outlined above.

3. Remove the six bolts which secure the

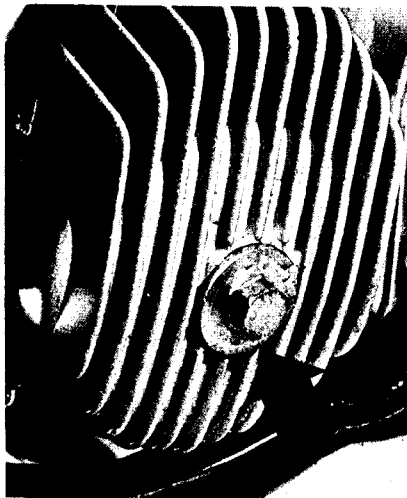

Oil filter bolt

oil filter screen and pull it out. Have a container beneath the screen cover to catch any oil which will drip out.

4. Clean the screen in a safe solvent and

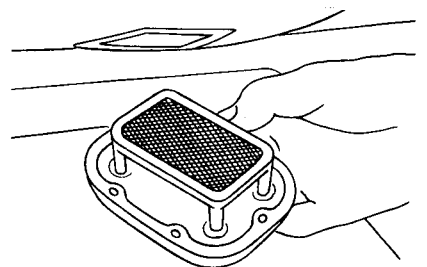

Removing the filter screen

use a reasonably soft brush, if necessary, to remove any foreign matter trapped on it. Check the condition of the gasket and replace it if necessary. Blow dry and reinstall, tightening the cover bolts gradually and evenly. Proper torque is 4.5–6.0 ft lbs.

5. Refill the crankcase with oil. Check for leaks.

## Front Forks

1. Yamaha fork oil, SAE 20W motor oil, or SAE 10W-30 motor oil is recommended for all forks.

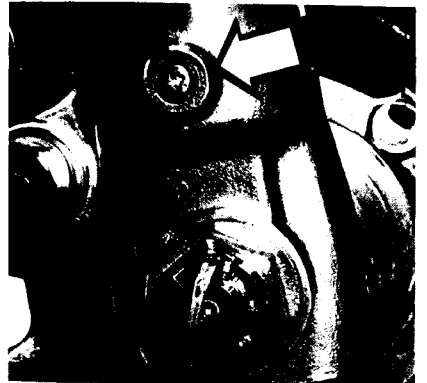

Front fork oil drain plug

Oil viscosity can be varied if slightly stiffer or less stiff fork action is desired. Special types of oil designed specifically for motorcycle forks can also be used, although care must be taken to flush the forks thoroughly when changing types or brands of fork fluid, since some may be incompatible with others.

2. After an initial change at 2,000 miles, the fork oil should be changed at 10,000 miles intervals.



Removing the rubber fork cap

3. Fork capacities are as follows:

XS360	
XS400D	130 cc (4.4 oz.)
XS400-2E	
XS400E	
XS400F, 2F	142 cc (4.8 oz.)
XS400G, SG-ON	

Note that the amounts shown are to be added to each fork leg.

4. Support the front wheel off the ground by placing a jack or the like beneath the engine.

5. Remove the rubber caps at the tops of the fork legs. Press down the fork caps slightly with a screwdriver or similar instrument, and remove the snap rings. Remove the fork caps. Pull out the fork springs.

6. Place a suitable container beneath one of the fork sliders and remove the drain screw. After most of the oil has drained off, pump the slider up and down a few times to



Fork filler cap

remove any oil remaining in the forks. Check the condition of the drain plug gasket and replace it with a new one if necessary. Refit the drain screw and tighten it securely.

Repeat the procedure with the other fork leg.

7. Examine the drained oil. If it contains water or is exceptionally dirty, it may be that the fork dust covers are damaged and allowing foreign matter to get past. This will also damage the fork seals quickly. Check that the dust covers are properly secured and replace

them if they are cracked, ripped, or otherwise damaged.

8. Add the proper quantity of oil to each fork leg.

9. Check the condition of the fork cap o-rings, and replace them if they are damaged. Refit the springs, fork caps, snap rings and rubber caps.

10. After several miles of operation, check the area around the fork slider seals for leaks or seepage. Even a minimal amount of seepage will require replacement of the seals. A coating of grime building up in this area over a period of time is also indicative of ineffective seals.

## Chassis Lubrication

1. The swing arm pivot is fitted with two grease nipples which should be lubricated with chassis grease every 2,000 miles. Apply grease until it shows at both ends of the swing arm pivot.



Swing arm grease fitting

2. Wheel and steering head bearings are lubricated with bearing grease, the service interval being 8,000 miles.

## SERVICE CHECKS AND ADJUSTMENTS

### Drive Chain

1. On 1976-78 models, the chain should have about 10-20 mm (0.4-0.8 in.) of total up-and-down free-play measured in the middle of the lower chain run.

On 1979 and later models, chain free-play should be 30-35 mm (1.2-1.4 in.).

2. Before checking or adjusting the chain slack, the following conditions should be met:

- The motorcycle should be placed on both wheels with a rider sitting with his weight on the seat.
- The transmission should be placed in neutral;
- The chain should be clean and well-lubricated;
- The chain should have been checked for any tight spots by slowly rotating the wheel and checking for variances in the chain tension at different points. If a tight spot exists, the chain tension should be ad-

justed to the prescribed free-play at the tight spot. Note, however, that such a con-

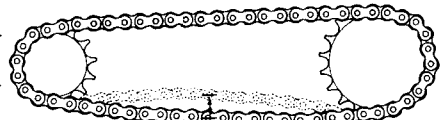

Chain play is the total up and down movement measured in the middle of the lower chain run



Chain adjusting bolt and swing arm alignment marks

dition is indicative of a worn chain and probably worn sprockets, which should be replaced as soon as possible.

3. To adjust the chain, first back off the rear brake adjuster nut on drum rear brakes.

4. Remove the axle nut cotter pin and loosen the axle nut several turns. Loosen the locknut on each chain adjuster bolt.

5. Turn each of the adjuster bolts in or out by equal amounts until the chain tension is approximately correct.

6. Check wheel alignment by means of the aligning marks inscribed on both sides of the swing arm. Be sure that both adjusters are lined up with the same mark on each side. If not, turn one of the adjuster bolts in or out so that alignment is achieved.

7. Tighten the axle nut and adjuster bolt nuts and check the chain tension. Correct if necessary. After adjustment is correct, torque the axle nut to 50-72 ft lbs.

Fit a new cotter pin. Readjust the rear brake on drum brake models.

### Clutch

1. Cable adjustment must always be maintained at the proper specification. If the cable has insufficient free-play, the clutch will slip and rapidly burn out. If it has too much play, the clutch will not completely disengage, resulting in hard shifting and creeping at stops.

2. Use the cable adjuster at the handlebar to maintain the correct amount of cable slack. The clutch hand lever should be able to be moved 2-3 mm (0.08-0.12 in.) measured between the lever and the lever holder before the clutch begins to disengage.

If clutch operation is not satisfactory after making this adjustment, proceed as follows:

3. Screw the cable adjuster at the lever in all the way thus increasing cable free-play.

4. Remove the clutch adjuster cover plug. Loosen the clutch adjusting screw locknut.

5. Turn the adjusting screw clockwise until a slight resistance is felt, then turn it counterclockwise 1/4 turn. Holding the screw in this position, tighten the locknut.

# Yamaha XS360-400

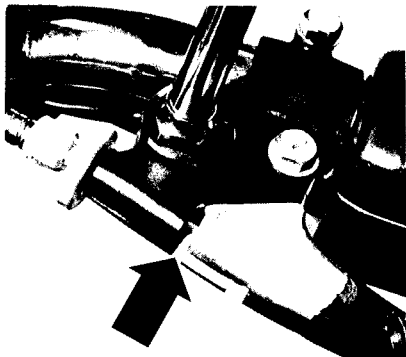

Clutch cable free-play (arrow) should be 2-3 mm (0.08-0.12 in.)

6. Turn the cable adjuster out until there is about 2-3 mm (0.08-0.12 in.) of free-play in the hand lever. Tighten the locknut on the cable adjuster.



Clutch adjuster screw and locknut

## Throttle Cable

1. The throttle cable is fitted with an adjuster at the twist-grip. The twist-grip should be able to be rotated approximately 10-15° (3-5 mm [0.12-0.20 in.]) before the throttle slides begin to open.

2. Use the cable adjuster at the handlebar to make and maintain this adjustment. To check that the cable has sufficient slack, start the engine and turn the forks slowly from lock-to-lock. Idle speed must not increase. If it does, it indicates that the cable has insufficient free-play, is incorrectly routed, or is binding at some point.

3. For complete carburetor adjustments, refer to "Tune-Up."

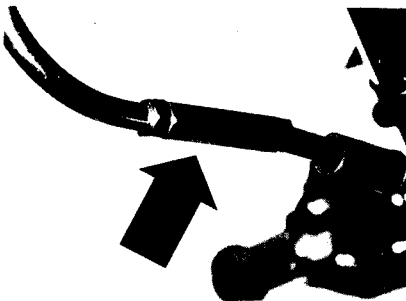

Throttle cable adjuster

1266

## Brakes FRONT DISC

Disc brakes need little attention other than a periodic check of the fluid level and of pad wear:

1. Check the brake fluid level relative to the lower level line inscribed on the see-through master cylinder reservoir. If the fluid level is below the inscribed line, add enough DOT 3 type brake fluid to bring the level up to the mark. Reinstall the master cylinder reservoir cap and tighten the screws securely.

*NOTE: The fluid level will drop slightly as the pads wear.*

2. To check brake pad wear, remove the wear indicator cap on the caliper. The pads should be replaced as a set if either of them is worn to the red limit line inscribed on them.

Refer to "Chassis," for brake system service procedures.

3. If the brake lever feels spongy, or if brake effectiveness has been reduced, a possible cause is air bubbles in the lines. To remedy this, bleed the system. This procedure can also be found in the "Chassis," section.

4. The brake lever should have about 13-25 mm (0.5-1.0 in.) of movement which is measured at the tip of the lever.

Lever movement is adjustable by means of an adjusting screw near the lever holder. Once set properly, the lever travel will not ordinarily need readjustment. If lever travel becomes excessive, it is more probable that



Front master cylinder brake fluid level line

the system needs to be bled or has some other fault. Adjusting brake lever travel will not remedy any brake system shortcomings.



Check brake pad wear here



Brake lever adjusting screw

## REAR DISC

1. The transparent master cylinder allows inspection of the fluid level without removing the master cylinder cap. If the fluid level is below the level mark, remove the cap and diaphragm and add enough DOT 3 brake fluid to bring the level up to the mark. Reinstall the diaphragm and cap and tighten it securely.

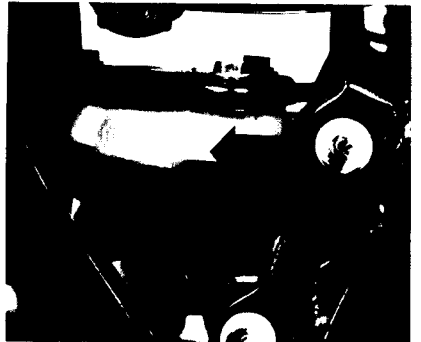

Rear master cylinder brake fluid level line

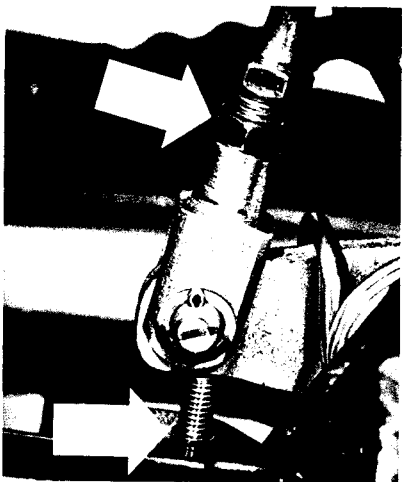

Brake pedal height adjusting bolt (lower) and brake rod adjuster locknut

2. Pad wear can easily be checked by visual inspection. Replace the pads as a set if either of them is worn to the red limit line.

3. To adjust brake pedal height and free-play, loosen the height adjuster bolt locknut.

Turn the adjuster bolt in or out so that the top of the pedal is about 12–18 mm (0.5–0.7 in.) below the top surface of the footpeg rubber. Tighten the adjuster bolt locknut.

Loosen the brake rod adjuster locknut and turn the brake rod until there is noticeable free-play between the rod and the master cylinder. Turn the brake rod in until it just touches the master cylinder, then back it out about 1½ turns. Tighten the locknut.

**CAUTION:** The pin hole mark on the brake rod must not show above the locknut.

This adjustment should yield brake pedal free-play of 13–15 mm (0.5–0.6 in.).

## FRONT DRUM

1. The brake should be adjusted so that the lever has 5–8 mm (0.2–0.3 in.) of free movement measured between the lever and the lever holder before the linings contact the drum.

2. The brake can be adjusted with either the cable adjuster at the brake plate or the adjustor on the handlebar. Loosen the locknut and turn the adjustor out to decrease brake lever movement. It is recommended that major adjustments be made with the adjuster at the brake plate and finer adjustments with the handlebar adjustor.

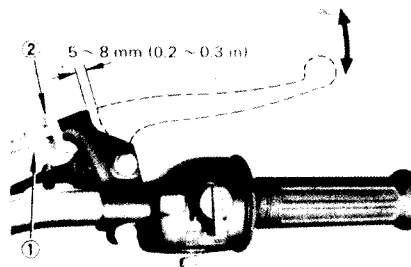

Brake lever free-play showing cable adjuster and locknut (1 and 2)

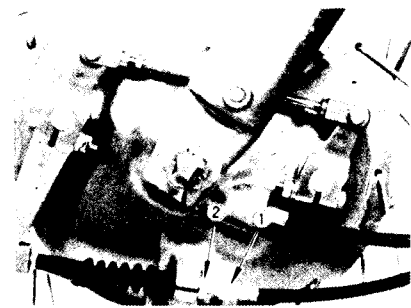

Brake plate adjuster and locknut (1 and 2)

## REAR DRUM

1. On early models with rear drum brakes, brake lining wear can be determined by means of the wear indicator pointer fitted to the brake lever on the hub. If the pointer lines up with the red slash mark when the brake pedal is fully applied, the linings are worn as far as possible for effective braking and should now be replaced.

On late drum-brake models, an inspection plug is fitted to the brake plate to allow direct inspection of the linings. They should be re-

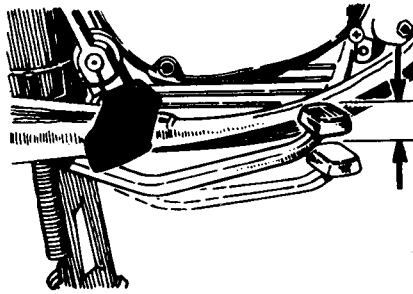

The brake pedal should have about 1 inch of movement before the linings contact the drum

placed when worn to less than 2 mm (0.08 in.). Thickness of new linings is 4 mm (0.16 in.).

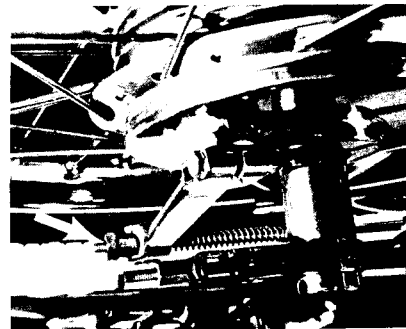

Rear brake adjusting nut

2. Observe the angle formed by the brake lever on the hub and the brake rod when the brake is fully applied. When the lever and rod form an angle greater than 90°, the shoes should be checked for wear as they probably are worn to the point of needing replacement.

3. The rear brake should be adjusted so that there is approximately 25 mm (1.0 in.) free-play at the pedal before the linings contact the drum. Adjust by turning the nut on the brake rod. When adjustment has been made, be sure that the nut is seated properly on the brake lever pin. Also, check the operation of the brake light switch.

4. Brake pedal height can be adjusted by means of the stopper bolt and locknut provided. The pedal height can be adjusted to suit personal preference, but it should generally be about ½ in. measured between the top of the rubber footpeg and the top of the brake pedal.

Be sure to check brake adjustment and brake light operation after making any change in the pedal height.

## Brake Light Switches

The switches should be checked for operation after the brakes are adjusted. The rear brake light switch and adjuster nut are mounted on a slotted bracket. The rear switch is adjusted by holding the switch and turning the adjuster nut to effect adjustment. Moving the switch up on the bracket allows the brake light to turn on sooner. Moving it down allows the light to turn on later. Do not turn the switch to effect adjustment as the wires will become twisted and may break.

The front disc brake switch is activated by the pressure of the brake fluid in the brake line. This switch is not adjustable; if defective, it must be replaced.

## Headlight Adjustment

1. Set the machine about 25 feet away from a wall, preferably of a color which reflects light well.

The machine should be off the stand, and with a rider putting his weight on the machine as in operation.

2. Switch on the high beam. The headlight high beam should be parallel to the ground and should hit the wall directly in front of the machine.



Headlight lateral adjustment screw

3. Vertical adjustment is made by first removing the headlight rim anchor screw and removing the headlight by prying at the point provided at the bottom. Slightly loosen the two headlight shell mounting nuts and install the headlight. Adjust the headlight by pivoting the shell up or down as needed. Remove the headlight and tighten the two mounting bolts. Install the headlight and tighten the anchor screw.

4. Lateral adjustment is accomplished by turning the adjusting screw on the side of the headlight. Tighten the screw to move the beam to the right; loosen it to move the beam towards the left.

## FUEL SYSTEM

Fuel system maintenance involves cleaning the petcock fuel filter screen, cleaning or replacing the air filter elements, and cleaning the carburetors.

The normal service interval is 2,000 miles.

## Petcock

The petcock is the vacuum-activated type which incorporates a mesh filter inside the gas tank.

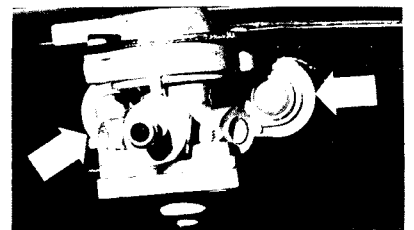

Petcock securing screws

# Yamaha XS360-400

1. Set the petcock to the "RES" position. Disconnect the fuel line from the manifold and the vacuum line from the manifold.

2. Remove the gas tank. Drain off the fuel.

3. Unscrew the petcock securing nut or two phillips screws depending upon the method of fastening, and pull off the petcock.

4. Clean the filter screen in a solvent. Be sure to remove any foreign matter trapped in the screen as this will impede fuel flow. If the screen cannot be cleaned, or if it is punctured or otherwise damaged, it should be replaced.

5. Check the sealing washer and replace it if it is damaged.

6. Install the petcock. After the tank is refitted, check for leaks before operating the motorcycle.

## Air Filters

1. Remove the side covers.

2. Loosen the carburetor clamp. Remove the element case holder screw, take off the securing band, and remove the element case.

3. Remove the case screws and separate the case halves, removing the filter element.

4. Blow out the elements from the inside with compressed air.

NOTE: After several such cleanings, the elements should be replaced with new ones. The service interval for replacement will depend upon the amount of dirt build-up on the elements.

5. Refit the elements into their cases and install them.



Air filter case holder and hose clamp screw

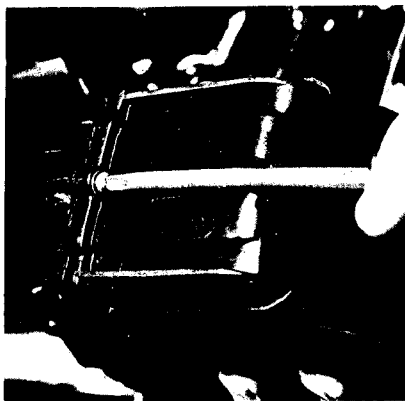

Separating the air cleaner case



Air filter element

## Carburetors

1. Although major overhaul of the carburetors requires their removal as a unit, the float bowls and jets can be cleaned with the units in place.

2. Make sure that the petcock is shut off ("RES" position). Drain the fuel from the carburetor float bowls by removing the main jet cover bolt from the bottom of the float bowls.

CAUTION: Do not let gasoline spill on a hot engine.

3. Remove the four screws which secure each float bowl and carefully lower the bowls until they are clear of the float mechanism.



Carburetor float bowl drain plug

4. Unscrew and remove the main and pilot jets. These are fitted to the float bowl on 360 models and are on the carburetor bodies on 400 models. Blow the jets clear, then reinstall. Clean any foreign matter out of the float bowls. When installing, position the bowls carefully to avoid damage to the floats. Tighten the screws gradually and evenly. Check for fuel leaks before operation.

## Periodic Maintenance Intervals ①

### Before each ride

- Safety items
- Operation of lights
- Chain adjustment
- Control cable adjustment

### Weekly

- Engine oil level
- Tire pressure (check when cold)
- Battery electrolyte level

### Every 200 miles

- Lubricate chain

### Every 1,000 miles

- Clean chain

### Every 2,000 miles/3 months

- Change engine oil
- Clean air filter
- Check swing arm
- Lubricate cables
- Check steering bearing adjustment
- Lubricate swing arm pivot
- Check rim run-out and spoke tension
- Check wheel bearings
- Clean fuel petcock and carburetors
- Check and adjust ignition timing
- Check spark plugs

### Every 4,000 miles/6 months

- Change oil filter
- Clean oil strainer
- Check compression
- Check cylinder head bolt torque
- Check oil pressure

### Every 10,000 miles

- Change fork oil

### Every 12,000 miles/24 months

- Flush and refill hydraulic disc brake system
- Repack wheel and steering head bearings

① Based on normal usage after initial service and break-in are completed.

## Recommended Lubricants

### Engine

- At ambient temperatures above 5° C (41° F):
  - Yamalube 4-cycle oil
  - SAE 20W-40 service rating "SE" or "SF"
- At ambient temperatures below 15° C (59° F):
  - SAE 10W-30 service rating "SE" or "SF"

### Front forks

- Yamaha fork oil
- SAE 20W motor oil
- SAE 10W-30 motor oil

### Disc brake systems

- DOT 3 standard brake fluid

### Control cables

- Light motor oil
- Graphite-based lubricant
- Molybdenum-disulphide-based lubricant

Tach, speedometer cables; throttle twist-grip  
Light duty grease

### Wheel and steering head bearings

- Waterproof, medium-weight bearing grease

### Grease fittings

- Waterproof, medium-weight chassis grease

### Drive chain

- Lubricant developed specifically for motorcycle drive chains

## Maintenance Data

	XS360	XS400
Fuel capacity (gal/1)	2.9/11	①
Oil capacity (qt/1)		
Routine change	2.1/2.0	2.1/2.0
Oil and filter change	2.4/2.3	2.4/2.3
After rebuilding engine	2.7/2.6	2.7/2.6
Front forks (oz/cc)	4.4/130	②
Tire pressure (psi)		
Solo (front/rear)	26/28	26/28
Two-up or extended high speed (front/rear)	28/33	28/33
Battery		
Voltage	12	12
Output (ah)	③	12
Continuous charging rate (amps)	④	1.2

- ① XS400D, 2E: 2.9/11  
XS400E, F, 2F, G, SG: 3.7/14
- ② XS400D, 2E: 4.4/130  
XS400E, F, 2F, G, SG, H: 4.8/142
- ③ XS360C: 12  
XS360-2D: 7
- ④ XS360C: 1.2  
XS360-2D: 0.7

## TUNE-UP

**NOTE:** Common tune-up procedures are explained in detail in the "General Information" section.

### COMPRESSION TEST

1. A compression check should be made before each tune-up since this will provide a general idea of engine condition.
2. It is necessary to have a gauge with the proper adapter (plug holes are 14 mm) if a screw-in type gauge is used. The less expensive "hold in" type gauges can also be used. Use some oil on the rubber tip to ensure a good seal.
3. The engine should be at operating temperature when checking compression.
4. Remove both of the spark plugs and fit the gauge to one of the plug holes.
5. Close the choke and hold the throttle wide open while spinning the engine with the starter motor or the kickstarter. Note the highest compression reading and repeat the test with the remaining cylinder.
6. Compression may vary according to gauge tolerance and several other factors. However, it should normally be between 140 and 170 psi. Both cylinders must be within 15 psi of this range and of each other.

### CAM CHAIN ADJUSTMENT

The cam chain tension is automatically regulated. No routine adjustment is required.

### VALVE ADJUSTMENT

**NOTE:** Valves must be adjusted when the engine is cold.

1. Turn the fuel petcock to the "RES" position. Disconnect the fuel feed line and the vacuum line from the petcock.
2. Remove the gas tank.
3. Remove the intake and exhaust tappet covers.
4. Remove the alternator rotor cover.
5. The valves for each cylinder are adjusted when the piston for the cylinder is at top dead center on the compression stroke. Use a wrench on the rotor nut so that the "LT" mark on the rotor is aligned with the stationary timing mark on the crankcase cover. Check that there is clearance at both valves for the left cylinder. There should be a



Alternator rotor cover allen bolts

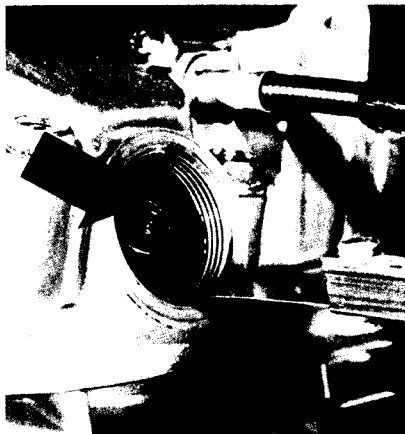

Checking valve adjustment

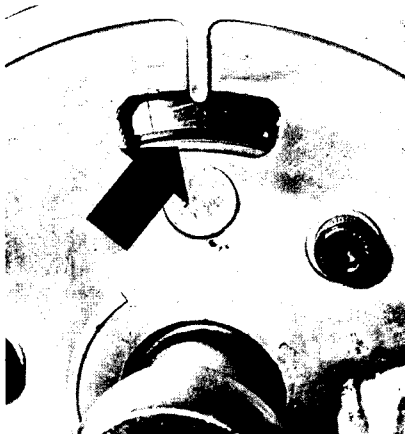

Alternator rotor aligned with timing mark to position right-side piston at top dead center

little movement in both rocker arms. If there is not, it indicates that the piston is at TDC on the *exhaust* stroke. If this is the case, rotate the engine through one full turn of the rotor and align the "LT" mark again. This should be TDC on the compression stroke.

6. Check the clearance between the rocker arm and the top of the valve for both intake and exhaust valves using the appropriate feeler gauges.

Clearances should be 0.08-0.12 mm (0.003-0.005 in.) for the intake, and 0.16-0.20 mm (0.006-0.008 in.) for the exhaust.

If the clearance is correct, a feeler gauge of the proper thickness will be a light slip fit between the rocker arm and valve.

7. If adjustment is necessary, loosen the adjuster locknut and turn the adjuster screw so that clearance is correct. Again, the feeler gauge should be a slip fit between the rocker arm and valve. Hold the adjuster in place and tighten the locknut securely. Recheck the clearance.

8. Turn the rotor one full turn so that the "RT" mark (for the right cylinder) is aligned with the stationary timing mark. Check that the piston is at TDC on the compression stroke by noting clearance at both valves as before. Check the right cylinder valves in the same manner.

**NOTE:** When the engine is at operating temperature, the valves should be very

quiet. Ticking from properly adjusted valves is sometimes due to the valve stem becoming indented by the valve adjuster screw. This should be confined to older machines, since the valve ends are stellite-coated. Indentations on the valve stem will give a false feeler gauge reading; the clearance will be too large. Valves can be checked by visual inspection by unscrewing the adjuster.

While more annoying than harmful, the only safe remedy for this situation is replacement of the valves.

### CONTACT BREAKER POINTS

#### Location

The contact breaker points are opened and closed by a cam on the end of the camshaft and are located beneath a cover on the left side of the cylinder head.

The timing advance mechanism is located behind the breaker point plate.

The condensers are mounted near the coils.



Breaker point cover screws

#### Replacement

1. Points sets purchased complete with the breaker plate can be easily replaced by disconnecting the primary wires at the connectors beneath the gas tank, removing the two large breaker plate securing screws, and carefully pulling off the old plate and points. After installing the new points and plate, the breaker point gaps and the ignition timing must be set (see below).

2. If the points are purchased separately, disconnect the primary wire at each point set, remove the securing screws, and remove the old points. When installing new points, note that the proper installation of the insulating washers at the primary terminal is critical. If improperly installed, no spark will occur. There is a small insulating tube which fits around the terminal bolt and two insulating washers, one immediately on either side of the terminal bracket. All connectors (primary wire, points spring) are made on the outer sides of these washers (i.e., no connector must touch the bracket, which is a ground).

3. New points may have a protective coating on the contact surfaces to prevent oxidation. Clean off these surfaces with a non-oily

# Yamaha XS360-400



Primary wire connectors beneath the gas tank

solvent before attempting to start the machine.

4. If the motorcycle will not start immediately after installation of new points, check that the primary wire connections under the gas tank are tight, that the insulating washers at the primary terminal are properly installed, and that the contact surfaces are thoroughly cleaned.

5. Condensers are easily replaced after disconnecting the lead near the coils and removing the screw which secures the condenser.

## Gapping

Periodic gapping is necessary to compensate for erosion of the contact surfaces due to electrical arcing and for wear of the fiber heel. As the heel wears, the points will open later relative to the rotation of the crankshaft, thus retarding the timing slightly.

Points should be filed (if necessary) and cleaned before gapping.

1. Remove the points cover.
2. Turn the engine over until one of the two sets of points is fully open.
3. With the proper feeler gauge blade, check the gap. The proper specification is 0.3–0.4 mm (0.012–0.016 in.), and the blade

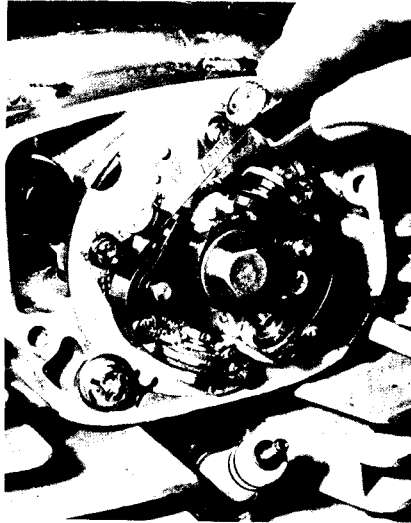

Checking point gap

should be a slip fit between the points if the gap is correct.

4. If adjustment is necessary, loosen the screws which secure the point set to its plate, and use a small screwdriver at the pry point provided to adjust the gap.

**CAUTION:** Loosen the screws just enough to allow the points to be moved. If loosened too much, the points will snap shut instead of holding the gap.

5. Tighten the screws and recheck the gap. It may change slightly when the screws are tightened.

6. Repeat the procedure with the remaining points set. Try to adjust both sets so that the feeler gauge blade has the same "feel" in both sets. This will help to ensure accurate timing.

7. If it is not possible to gap the points correctly, the fiber heel is evidently worn; the points should then be replaced.

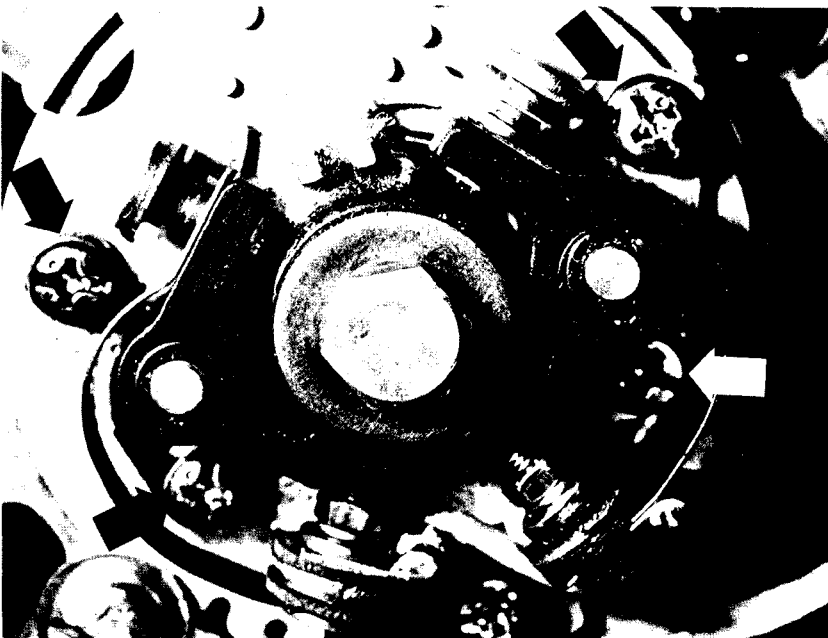

Loosen the screws indicated by arrows to adjust the point gap for both point sets

## Lubrication

1. On all models it is necessary to occasionally lubricate the cam follower fiber heel and the pivot point of the contact breaker. This minimizes wear and ensures that the timing will remain accurate for a longer period. A worn heel will retard the timing.

2. A small dab of grease (high melting point, if possible) should be applied to the lubricator wick so that the lubricator can distribute it onto the breaker cam. A drop of engine oil should be applied to the pivot point.

3. In both cases it is imperative that care be taken to keep the lubricant away from the points contact surface.

4. The lubricating wick should be adjusted so that it just contacts the breaker cam.

## IGNITION TIMING (BREAKER POINT MODELS)

All models except the XS400G/SG and H models are fitted with contact breaker points. Procedures for the transistorized ignition found on the G/SG and H models are given in the next section.

The rotor marks are interpreted as follows: "LT" indicates top dead center for the left piston, "RT" for the right piston. "LF" and "RF" are the fixed-advance firing points for the two pistons, which is about 10° before TDC. There are, in addition, two other marks, and these represent the full-advance firing points, which is about 36° before TDC. Timing advance begins at about 2500 rpm.

**NOTE:** Points must be cleaned and gapped before checking timing. Dirty points will cause inaccurate readings.

Remove the points cover and observe the breaker plate. Note that the points for the left cylinder (orange lead) are mounted directly to the large breaker plate, while the points for the right cylinder (grey lead) are mounted on a smaller moveable plate. Therefore, the left cylinder timing must be set first, since adjustment involves turning the entire breaker plate, which will alter the timing of the right cylinder as well. The points for the right cylinder are adjusted by moving only the points themselves.

## Dynamic Timing

1. Park the bike on the centerstand in a well-ventilated area.

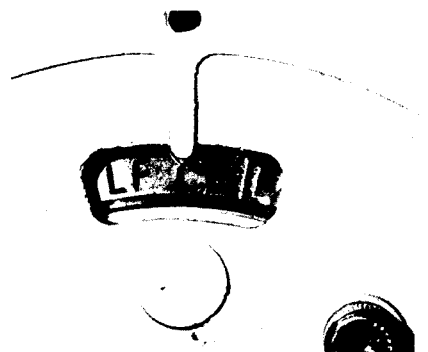

Static firing point for the left-side cylinder



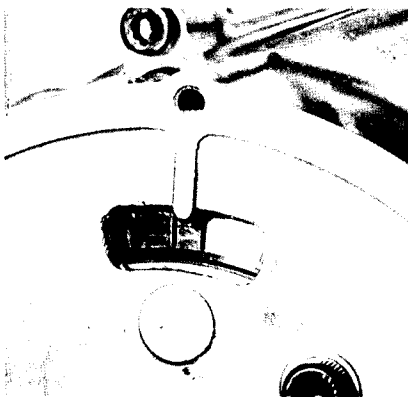

Full advance firing point is indicated by two lines

2. Remove the points cover and the alternator rotor cover. Clean and gap both sets of points as previously described.
3. Hook up the strobe light according to the manufacturer's instructions to pick up impulses from the left cylinder.
4. Start the engine and adjust the idle speed, if necessary, to 1,200 rpm.
5. Aim the timing light at the marks on the alternator rotor visible through the cut-out. At idle, the "LF" mark on the rotor should align with the stationary timing mark.
6. To check the ignition timing at full advance, increase engine speed until the motor is turning 2,500-3,000 rpm. At this point, the stationary timing mark should be between the two full advance marks scribed onto the alternator rotor.
7. If adjustment is necessary, loosen the two large base plate screws, and rotate the

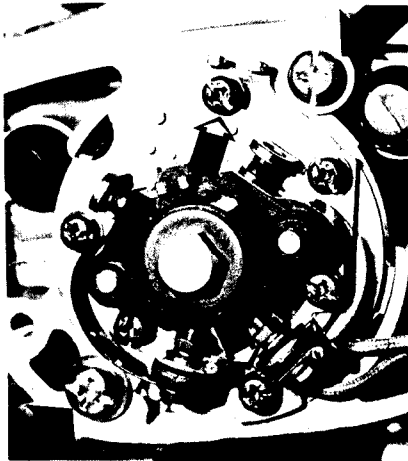

To adjust the timing for the left cylinder, loosen the two breaker plate screws (large arrows) and rotate the entire plate. To adjust the right cylinder, loosen the two point screws (smaller arrows) and move the right cylinder's points

entire plate so that the proper marks align at the specified rpm. Establishing this alignment at full advance is recommended. Tighten the base plate screws.

8. Repeat the procedure, this time having the strobe light pick up the right cylinder. If adjustment is necessary, loosen the two small phillips screws which secure the points set to its plate, and use a small screwdriver at the pry point provided to move the

set so that proper mark alignment is achieved. Tighten the screws.

9. If it is not possible to achieve full advance alignment without moving the base plate or the right points set all the way to the end of their range of allowable travel, it is possible that the points are either incorrectly gapped, or that they are worn to the point where they must be replaced.

## Static Timing

1. Remove the points cover and the alternator rotor cover.
2. Clean and gap both sets of points as described previously.
3. Connect one lead of the tester or test light to the primary wire terminal for the left cylinder (orange lead), and the other tester lead to ground on the engine or frame.
4. If the test device is not self-powered, turn the ignition switch *on* and be sure the kill switch is in the middle position.
5. Turn the engine over in the normal direction of rotation until the "LF" mark aligns with the stationary timing mark. The test instrument should react at the instant these marks align, indicating that the points have opened. If they do not, loosen the two large screws which secure the points base plate and rotate the plate so that the points just open when the timing marks are in alignment. Tighten the base plate screws and recheck the timing.
6. Repeat the procedure with the right points set. If adjustment is necessary, loosen the two screws which secure these points to their mounting plate and use a small screwdriver at the pry point provided. Tighten the screws and recheck the timing.

## IGNITION TIMING (XS400G/SG,H)

Because of the transistorized spark unit which is used in place of the more conventional breaker points, ignition timing for these models need not be checked unless the pick-up unit is removed.

If a check is required, note that the "LF" timing mark on the rotor should align with the index mark at 1200 rpm. Dynamic timing (using a strobe light) is the only method of checking the timing. Adjustment is not possible. If the marks are not properly aligned at the given speed, the only cause would be a loose spark unit rotor bolt.

## CARBURETORS

Carburetor adjustments to be made during a tune-up include setting float level, synchronization, and idle speed and mixture.

### Adjusting Float Level

1. Float level is a measure of the amount of gasoline which will be in the float bowls during operation. While it is a critical specification, it will not normally need readjustment once properly set. Float level, therefore, need not be checked at every tune-up, but should be attended to from time to time.
2. Remove the carburetors.
3. Remove the float bowls. Remove the gasket. With the carburetor(s) positioned

vertically, lower the float until the float arm just touches but does not depress the tip of the float needle. Float level is the measured distance from the bottom of the float to the float bowl mating surface.

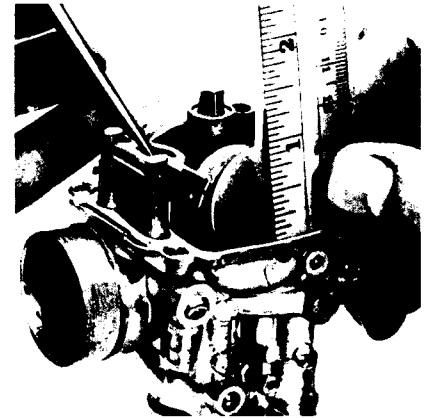

Checking float level

4. Float level for each model is given in the "Tune-Up Specifications" chart at the end of this section. Adjust, if necessary, by pushing out the float pivot pin, removing the floats, and bending the float arm tang. Bending the tang towards the carburetor body will increase the float level measurement and vice-versa.

5. Both carburetors must have the same float level. Measure both before changing either. Note that the measured float level will be inaccurate if the float needle tip is worn or if there is foreign matter on the needle seat.



Adjusting the float tang

### Synchronization

Vacuum gauges are necessary to properly synchronize the carburetors, although a rough approximation can be made by visually aligning the butterflies (see below).

The butterflies are synchronized by means of a single screw located between the two carburetors. Turning the screw simultaneously closes one butterfly while opening the other.

1. Run the engine until operating temperature is reached.
2. Remove the gas tank's rear mounting bolt and raise the tank (fitting a longer fuel

# Yamaha XS360-400

feed line if necessary, so that the synchronization screw between the carburetors is accessible.

3. The vacuum gauge fittings are on the manifolds. The vacuum gauge fitting for the right cylinder operates the fuel petcock. Disconnect the petcock line from the fitting, and turn the petcock to the "Prime" position for the duration of the procedure.

4. Connect the vacuum gauges.

5. Start the engine and note the vacuum readings. At idle (1,200 rpm) the two cylinders

must be within 5 cm Hg (0.2 in. Hg). Adjust, if necessary, by turning the synchronization screw in or out until the vacuum readings for the two cylinders is as identical as possible.

**NOTE:** If the vacuum gauges read more than 5 cm Hg (0.2 in. Hg) at 1,200 rpm, check the compression, spark plugs, ignition timing, and valve clearance.

6. If vacuum gauges are not available, a rough method of synchronizing the carburetors may be carried out. Remove the carburetors as a unit from the motorcycle. Look into the engine side of the carburetors and note the relative positions of the edges of the butterflies in relation to the small by-pass passages in the bottom of the bores. Both butterflies should be in the same position relative to these by-pass holes.

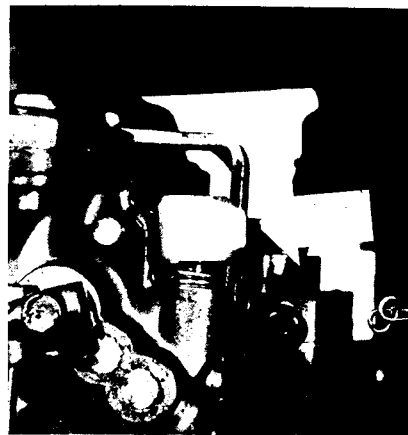

Pilot screw

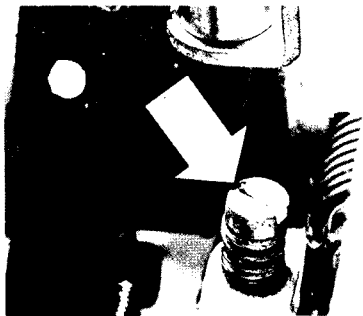

Carburetor synchronizing screw

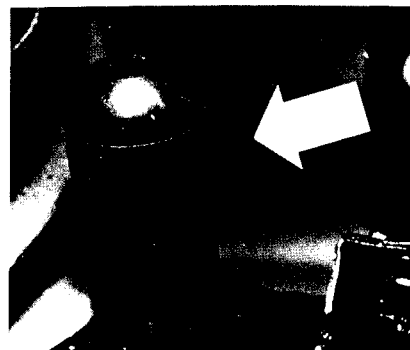

Manifold vacuum fitting (left side)

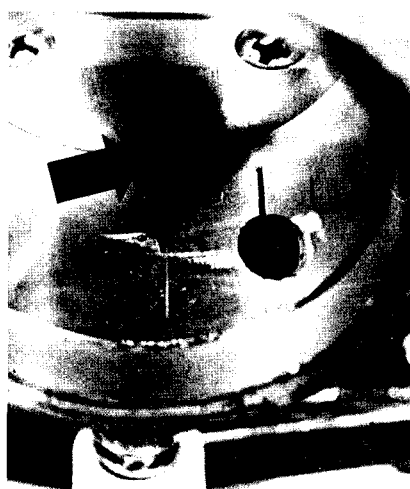

Aligning both butterflies relative to the bypass outlet is a rough way to synchronize the carburetors

## Idle Speed and Mixture

1. The idle mixture is controlled by a pilot screw fitted to each carburetor. The screws are fixed in position by means of idle limiter caps. This is designed to reduce emissions. Therefore, it is not generally necessary to adjust the pilot screws.

2. If the limiter caps are missing, or if the pilot screws have been removed (as during a carburetor overhaul), pilot screw adjustment is accomplished by screwing the pilot screws in (very carefully) until lightly seated, then backing them out 1½ turns on 360 models and 1¼ turns on 400 models.

3. Idle speed is set by means of the throttle stop screw between the carburetors. Idle speed is 1,200 rpm, and must be adjusted when the engine is at operating temperature.

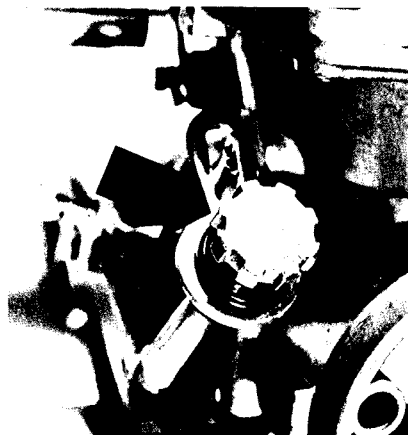

Throttle stop screw

## Tune-Up Specifications

Item	XS360	XS400D/E	Other Models
<b>Compression</b>			
Cranking pressure (psi)	140-170	140-170	140-170
Max allowable variation (psi)	15	15	15
<b>Valve clearance</b>			
Intake (mm/in.)	0.08-0.12/0.003-0.005	0.08-0.12/0.003-0.005	0.08-0.12/0.003-0.005
Exhaust (mm/in.)	0.16-0.20/0.006-0.008	0.16-0.20/0.006-0.008	0.16-0.20/0.006-0.008
<b>Ignition</b>			
<b>Spark plugs</b>			
OEM	NGK/Champion	NGK/Champion	NGK/Champion
Standard	BP-6ES/N-7Y	BP-7ES/N-7	BP-6ES/N-7Y
Hot	BP-5ES/N-13Y	BP-6ES/N-13Y	BP-5ES/N-13Y
Cold	BP-7ES/N-8Y	BP-8ES/N-8Y	BP-7ES/N-8Y
Spark plug gap (mm/in.)	0.7-0.8/0.028-0.032	0.7-0.8/0.028-0.032	0.7-0.8/0.028-0.032
Breaker point gap (mm/in.)	0.3-0.4/0.012-0.016	0.3-0.4/0.012-0.016	0.3-0.4/0.012-0.016
<b>Ignition timing</b>			
Static (degrees BTDC)	10	10	10
Maximum (degrees BTDC @ 2500 rpm)	36	36	36
<b>Carburetion</b>			
Idle speed (rpm)	1,200	1,200	1,200
Pilot screws (turns out)	1½	1¼	not adjustable
Vacuum uniformity (cm/in. Hg)	5/0.2	5/0.2	5/0.2
Float level (mm/in.)	26.6/1.05	32.0/1.26	ⓐ

ⓐ XS400-2E: 25.7/1.0  
XS400F/2F: 32.0/1.26.  
XS400G/SG,H: 27.3/1.1

## ENGINE AND TRANSMISSION

**NOTE:** Common engine rebuilding techniques and inspection procedures are given under "Engine Rebuilding" in the General Information section.

### ENGINE SERVICE

1. The cylinder head, barrels, and pistons can be removed with the engine in the frame.
2. Crankcase cover components such as the clutch, oil pump, kickstarter assembly, alternator, etc., can also be serviced without removing the engine.
3. Service to the crankshaft, transmission, and gear shift components requires removal of the engine.
4. Read each procedure carefully before beginning so that replacement items such as gaskets, o-rings, etc., can be purchased before-hand.

### ENGINE REMOVAL AND INSTALLATION

1. Clean and degrease the engine thoroughly before removal. This will minimize chances of foreign matter getting into the crankcase during the disassembly procedure.
2. Disconnect the fuel line from the petcock, the vacuum line from the right manifold, the bolt from the rear of the tank, and remove the gas tank.
3. Drain the crankcase oil. Remove the oil filter housing.
4. Remove the side covers. Remove the air filter boxes. Remove the air filter hoses from the carburetors.
5. Disconnect the throttle cable from the linkage, loosen the carburetor clamps, and remove the two carburetors as a unit.
6. Remove the mufflers and header pipes.
7. Remove the rider footpegs.
8. Remove the rear brake pedal.
9. Remove the gearshift lever from its shaft.
10. Disconnect the spark plug caps and loosen the plugs.
11. Disconnect the tachometer cable from the cylinder head.
12. Remove the engine sprocket cover. Disconnect the clutch cable.
13. Disconnect the breaker point leads and the alternator wires at the connectors.
14. Disconnect the started motor lead from the solenoid.
15. Disconnect the battery ground lead.
16. To remove the engine sprocket, temporarily fit the gear shift lever, engage the transmission, fit the rear brake pedal, apply the brake, and remove the engine sprocket nut. Remove the sprocket from its shaft. It may be necessary to move the rear wheel forward to yield sufficient chain slack to allow this.
17. Remove the engine mounting bolts and take the engine out of the frame.
18. Installation is the reverse of removal. Note the following points:
  - a. Install the engine in the frame from the right side.

- b. Tighten the 10 mm nuts to 18-30 ft lbs. Tighten the 8 mm nuts and bolts to 10-21 ft lbs.

### TOP END

#### Cylinder Head Removal

1. Remove the gas tank by disconnecting the fuel line from the petcock and the vacuum line from the manifold and the rear tank mounting bolt.
  2. Disconnect the throttle cable at the carburetors. Loosen the carburetor manifold and air cleaner hose clamp screws and remove the carburetors as a unit.
  3. Remove the exhaust system. Disconnect the spark plug caps. Remove the plugs.
  4. On breaker point-equipped models, disconnect the point leads at the connectors. Remove the breaker point cover. Remove the point assembly. Pull off the timing mechanism. Disconnect the tachometer cable from the cylinder head.
- On transistorized ignition models, a special procedure is necessary. Proceed as follows to remove the pick-up coil which is fitted in place of the breaker points:

- a. Centerpunch the blind plug which secures the pick-up coil cover. Use a 5 mm drill bit to drill the plug.

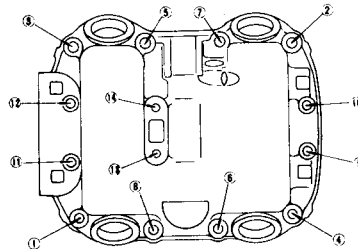

Cylinder head cover bolt loosening order



Removing the camshaft. Note cam chain secured by wire



Removing the cam chain guide

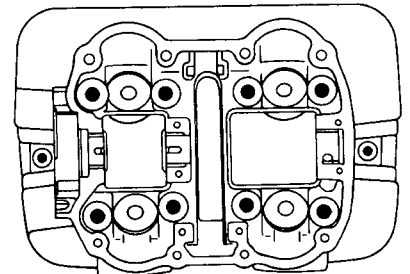

Cylinder head nuts and bolts



Removing the cam chain tensioner assembly

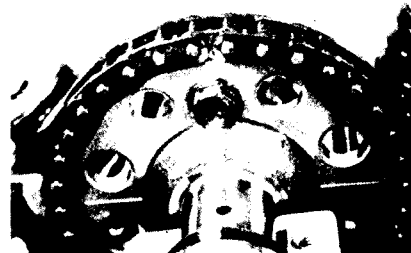

Camshaft sprocket bolt

- b. Cut internal threads 6 mm diameter x 1.0 mm pitch in the blind plug with a proper size tap. Thread in the special slide hammer or a suitable metric bolt, and pull out the plug.
  - c. Remove the cover screws and take off the cover.
  - d. Remove the rotor bolt and the rotor.
  - e. Remove the pick-up coil screws and remove the assembly.
5. Remove the cylinder head-to-frame mounting nuts and bolts.
  6. Remove the cylinder head cover bolts. Loosen the bolts gradually and in a cross pattern. If the cover is stuck, tap around the sides with a plastic mallet to free it.
  7. Remove the alternator rotor cover.
  8. Take out the cam chain tensioner assembly. Note the location of each part.
  9. Turn the engine over, if necessary, so that one of the cam chain sprocket bolts is accessible. Remove the bolt. Turn the engine over so that the other bolt can be removed.
  10. Loop a length of wire through one of the cam chain sprocket holes and anchor the wire to the engine. Remove the camshaft.
  11. Remove the cam chain guides.
  12. Remove the cylinder head nuts and bolts. Remove the cylinder head.

# Yamaha XS360-400

## Cylinder and Piston Removal

1. Lift the cylinder a few inches off its seat and stuff a clean, lint-free rag or rags beneath the pistons. This is to prevent any foreign matter or pieces of broken piston ring from falling into the crankcase when the cylinders are removed.

2. Lift the cylinder straight up and free of the studs.

3. With a needle-nosed pliers, remove the wrist pin circlips from the pistons. Push out the piston wrist pins and remove the pistons from the rods.

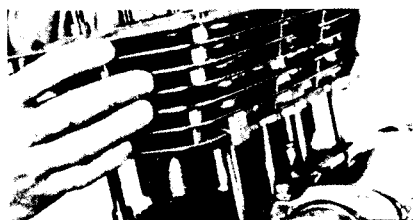

Removing the cylinders



Removing the piston wrist pin circlip

Support the piston with one hand while pushing out the wrist pin to minimize chances of bending the rod. Push the pin out with steady pressure. Do not use an impact method. If the wrist pins resist removal, heat the piston crown gently and evenly with a propane torch until the pins can be easily pushed out.

Discard the wrist pin circlips. New circlips must be used on assembly.

4. Mark each piston so that it can be installed in its original cylinder on reassembly.

## Inspection CAMSHAFT

1. Check the cam lobes for flaking, scoring, or blue discoloration, and replace the cam if any of these signs of damage are present.

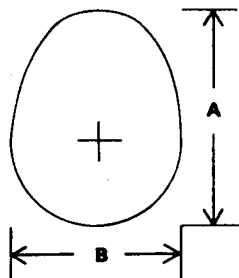

Measure cam lobe height (A) and base circle diameter (B)

2. With a micrometer, measure the height of each cam lobe and compare the measurement with the specifications given in the chart at the end of this section.

3. Measure the base circle of each cam lobe. This measurement is taken in a plane perpendicular to the cam height measurement through the camshaft centerline. Refer

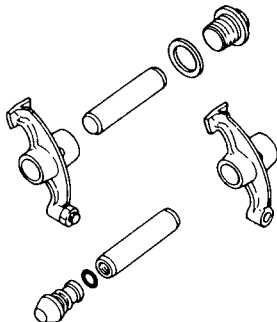

Rocker arm assembly

to the specifications chart at the end of this section.

4. Mount the camshaft in a set of v-blocks and measure run-out with a dial gauge. If run-out exceeds 0.03 mm (0.0012 in.), the cam should be replaced.

5. Check the cam bearings for scoring and wear. Check the journals as well. Measure the journal diameters, referring to the specifications chart at the end of this section.

## ROCKER ARMS AND SHAFTS

1. The rocker arms are fitted to the cylinder head cover. To remove them, remove the rocker arm shaft covers and grommets. Thread an 8 mm screw into each shaft and pull it out. If the shaft resists removal, use a slide-hammer to effect removal.

2. Check the condition of the rocker arm bores and the corresponding areas of the shafts. Note any blue discoloration which might be due to excessive heat or lack of lubricant. Replace the rocker arms and shafts if this condition exists, or if there are obvious signs of damage, such as scoring.

3. Check the cam contacting pad of each rocker arm for pitting or wear. Replace the arm if wear is evident.

4. Measure the inside diameter of the rocker arm bore and the outside diameter of the shaft. Standard clearance is 0.016–0.054 mm (0.00063–0.00212 in.). If the clearance exceeds 0.1 mm (0.004 in.), replace the components.

## CYLINDER HEAD

1. Clean any traces of head gasket material from the cylinder head mating surface. Place a straight edge across the mating surface and check for warpage by attempting to slip feeler gauge blades between the head and straight edge. Standard head warpage is about 0.05 mm (0.002 in.), and maximum allowable warpage is 0.1 mm (0.004 in.). At this point, the head should be milled to restore a flat mating surface.

2. Use a wire brush fitting on a power drill to decarbonize the combustion chambers. The valves should be left in place as this is done, as it minimizes the chance of causing damage to the valve seats.

## VALVE ASSEMBLY

Before removing the valves, check their sealing ability by pouring a small quantity of gasoline into each port and allowing the head to sit for about five minutes. If the valves are properly seating, leakage into the combustion chamber will be minimal.

1. To remove the valves, and install them properly, a suitable C-clamp is necessary. Compress the valve springs and remove the split collars, retainers, springs, seals, and spring seats. Inspect the valves, guides, springs, and valve seats in the following manner. Keep each assembly separate so that every piece can be installed in its original location. New valve seals must always be used on assembly.

2. If considerable mileage has been covered, the valve springs should be replaced as a matter of course. Always replace valve springs as a set.

Measure the free-length of each valve spring with a vernier caliper. If any of the springs is more than 2 mm (0.08 in.) less than the standard free-length given in the specifications chart at the end of this section, the springs should all be replaced.

3. Each valve must be free to move up and down in its guide with little resistance. Any sticking or binding as the valve is moved in the guide will indicate that the valve stem or guide is in poor condition.

4. Inspect the valve, paying close attention to the edges of the valve head for pitting, burnt or broken edges, excessive carbon build-up, etc. A certain amount of carbon and lead deposits on the valve face and the top of the exhaust valve are inevitable. Heavy deposits should be carefully scraped off with a dull knife, or a wire wheel, and the valve finished up with very fine emery cloth.

Do not touch the valve seating area during these operations.

If the valve has burnt or broken edges, it must be replaced.

5. Check the end of the valve stem for indented wear caused by the valve adjuster. Although rare, it may occur after long mileage. Since an indentation here will make proper valve adjustments impossible, the valve should be replaced.

**NOTE:** The tips and edges of the valves are stellite-coated. Machining for any reason is not recommended. In case of wear, replace the valve.

6. Carbon deposits should not extend too far up along the valve stem. This would indicate a worn or cracked valve guide.

7. Wet, oily deposits on the back of the valve head is indicative of a worn guide or bad seal. Less severe wear to these components show up as brown oil stains on the valve stem.

8. Holding a valve in your fingers, spin it while observing the head. A wobble is indicative of a bent valve. If a dial gauge is available, check the run-out of the head. Replace the valve if run-out exceeds 0.03 mm (0.0012 in.). Run-out is the total indicated dial gauge reading.

Attempt to rotate the valve by hand when it is fully inserted into the guide. If the valve will not rotate easily, or if it sticks as it is turned, it is probably bent.

9. Check valve-to-stem clearance and compare to the specification given. Insert the valve in the guide, holding it about 1/2 in. off

the seat; check the total amount of allowable movement in two directions using a dial gauge.

Maximum allowable clearances are 0.08 mm (0.003 in.) for the intake valves and 0.1 mm (0.004 in.) for the exhaust valves. If the measured clearances exceed these amounts, replace both valve and guide.

A quick check of the operational worthiness of a valve and guide can be accomplished by dipping the valve stem in oil and inserting it into its guide. Place a finger over the other end of the guide. Pull the valve a little way out of the guide and release it. The valve should be drawn back into the guide by suction if the components are in serviceable condition.

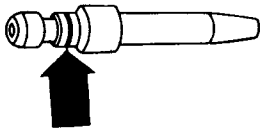

Oversized valve guides are identified by a groove around the upper part of the guide

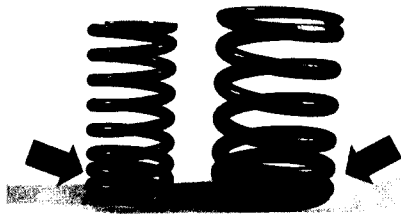

Valve springs are installed with the close coils (arrows) towards the head

10. Measure the diameter of each valve stem at three places along the length of the valve. Check the measurement against the standard diameter given in the chart at the end of this section, and replace the valve if any of the measurements is below the standard.

11. To replace a valve guide, heat the cylinder head in an oven to a temperature of 212°F (100°C). Drive out the old guide(s) with a suitable drift. Drive in the new guide(s) until fully seated. Use new o-rings.

**NOTE:** When replacing valve guides, use the special oversized guides. These are easily identified since they have a groove around the upper part of the guide.

After installation, ream the new guide(s) with a 7 mm reamer. Clean the inside of the guide thoroughly afterwards.

12. After installing new guides, the valve seat should be recut and the valve lapped in.

13. Check the width of the valve seat on the valve. It should be about 1.0 mm (0.04 in.) all the way around. If narrower or wider than this, or if width varies around the valve, the seat should be recut and the valve lapped in.

**NOTE:** Valve springs are progressively wound. When installing them, be sure they are fitted with the close coils towards the cylinder head.

## SEAT CUTTING

1. Use a machinist's dye to check the width and position of the valve seat. Apply the dye to the valve's beveled seating area

and a very small amount of grinding compound to the valve seat in the head. Spin the valve back and forth against the seat for several seconds, then remove the grinding compound and inspect the pattern of the seat, from which the dye will have been removed.

2. The valve seat should be about 1.0 mm (0.04 in.) wide and even in width all around the valve. The maximum acceptable seat width is 1.5 mm (0.06 in.).

3. If the seat is uniform in width but is too wide, use a flat cutter, then a 30° cutter to reduce the seat width to within specification.

4. If the seat is centered on the valve face, but is too narrow, use a 45° cutter to increase the width to the proper specification.

5. If the seat is too narrow, and is towards the top edge of the face, first use a flat cutter, and then the 45° cutter.

6. If the seat is too narrow and positioned towards the bottom edge of the face, use a 30° cutter first, then a 45° cutter.

## LAPPING

1. Valves should be lapped into their seats if the leakage test shows poor sealing, if the seat has been recut, if the valve edges or seat in the head are pitted, if the motorcycle has covered considerable mileage, or if new valves or guides are fitted.

2. Clean off all carbon build-up on the surface of the combustion chamber. Place three small dabs of valve lapping paste around the circumference of the valve head and place the valve into the guide.

3. If you have a lapping tool, use it as the manufacturer directs. Usually the tool will turn the valve back and forth while rotating it around the seat at the same time. Do not use excessive pressure during the operation.

If you do not have such a tool, a piece of thick fuel line placed over the valve stem works just as well. Turn the valve back and forth and rotate it to a new position every few seconds.

**NOTE:** Check the condition of the valve face and seat frequently. When a smooth, even finish is evident, stop lapping. Excessive lapping may lead to a pocketed valve.

4. Remove the valve and clean it thoroughly. Remove any traces of lapping compound from the seat and the combustion chamber. Swab out the guide with a cotton swab soaked in a solvent. Squirt a little oil into the guide so that it may carry away any particles inside.

## CYLINDERS AND PISTONS

1. Make a visual inspection of the cylinder bore, noting any imperfections. The cylinder walls should be uniformly smooth.

2. With an inside micrometer, measure the diameter of each bore at the top, middle, and bottom. Make measurements in two directions, 90° apart, both parallel and perpendicular to the piston wrist pins.

If the difference between the high and lower measurement in any one direction (taper) is greater than 0.05 mm (0.002 in.), or if the difference between two measurements at any point on the cylinder (out-of-round) exceeds 0.01 mm (0.0004 in.), the cylinders should be bored to the next oversize and fitted with new pistons.

3. Make a visual inspection of the pistons. Scoring, scuffing, or seizure marks on the piston skirts may be removed with a fine grade of emery or crocus cloth if they are not

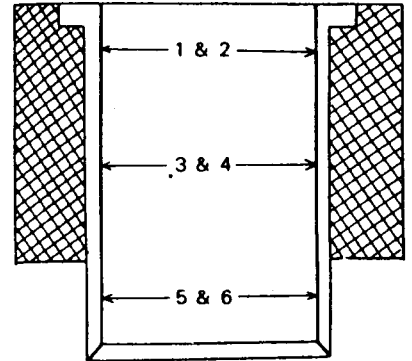
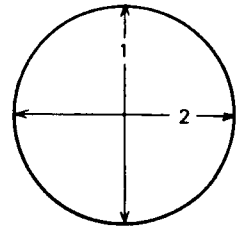

Cylinder bore measurement points

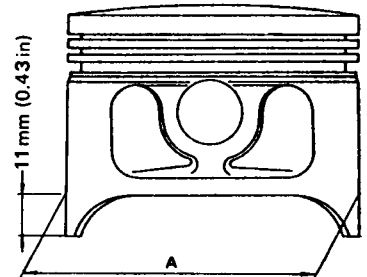

Measure the piston diameter 11 mm (0.43 in.) above the bottom edge of the skirt and perpendicular to the wrist pin

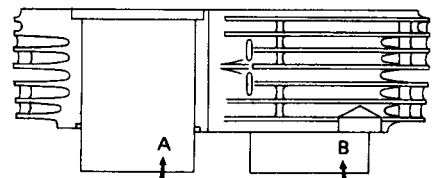

Cylinder grading mark locations

too severe. Sanding should be done in a cross-hatch pattern. If the damage is severe (more than about 1/2 in. wide), the pistons should be replaced.

4. The rings must be free to move in the piston grooves. If they cannot, either they are carbon clogged (which necessitates replacing the rings and cleaning out the grooves), or metal has been pushed into the grooves by a piston seizure. In this event, pistons and rings must be replaced. Carbon-clogged rings are almost always broken when an attempt is made to remove or free them, so be prepared to buy a new set.

5. Pistons are available in four oversizes in increments of 0.25 mm.

To determine piston diameter, use a micrometer and measure the diameter in a direction perpendicular to the wrist pin at a point about 11 mm (0.43 in.) above the bottom edge of the skirt.

# Yamaha XS360-400

Bore the cylinders so that the piston clearance will be 0.030–0.050 mm (0.0012–0.0020 in.).

6. If only the pistons are being replaced, and no boring is being done to the cylinders, note that pistons and cylinders are graded "A" or "B". The piston is marked on the crown, and the cylinders at the cylinder base. Fit "A" pistons with "A" cylinders and "B" pistons with "B" cylinders.

7. Check the condition of the wrist pins. If the pins are blued or show indications of step-wear, they should be replaced. Usually, step-wear can be detected by running a fingernail along the length of the wrist pin. A more conclusive method is to measure the diameter of the pin at three places along its length and compare the readings.

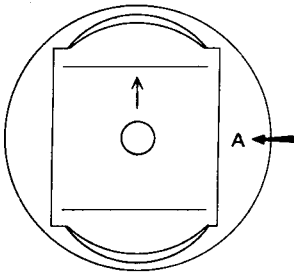

Piston grading mark locations

8. Insert each wrist pin into its piston and check for play of the pin in the piston hole. There must be none. The pin must be a fairly tight fit. If the pin is easily inserted and can be turned or moved vertically with no effort, the pistons should be replaced.

9. Lightly oil each wrist pin and insert it into its connecting rod. Check for vertical play. There should be none. If play exists, or if the rod small end is discolored, the rod and/or pin should be replaced.

10. Check the connecting rods for a bent condition. This can be accomplished with two small rectangular blocks of metal of equal thickness. Insert the wrist pins into the rods, and position the pieces of metal beneath them on either side of the rods and resting on the crankcase. Rotate the engine so that the wrist pin rests on the blocks. Both sides of the wrist pin must contact the metal blocks, or the rod is bent and must be replaced.

11. Before installation, decarbonize the piston crowns. Remove any carbon from the ring grooves with a piece of broken ring or a very thin screwdriver. Be careful not to scratch the grooves.

Carefully check the cylinder, cleaning the bore thoroughly. If considerable mileage has been covered, honing the cylinders and fitting new rings is recommended. If the cylinders are honed, make a strenuous effort to clean them thoroughly afterwards, preferably with very hot soapy water and a stiff brush. This is to remove any abrasive particles deposited by the hone in the course of the operation.

Remove any traces of gasket material from the cylinder base and the head mating surface.

12. Be sure that all oil passages in the cylinder are clear. Check the condition of the cam chain tensioner guides and replace them if damaged.

13. Replace the cylinder base o-rings.

Check that any o-rings and the important dowel pins fitted to the cylinders are in their proper locations before installation.

## PISTON RINGS

Two checks to be made on the piston rings are side clearance and end-gap. These checks should be made on both new and used rings.

1. Piston ring side clearance for compression rings is checked with the rings installed on the piston. Insert a feeler gauge blade between the ring and the ring groove and check that the clearance is within the specification given for your machine in the "Engine Specifications" chart at the end of this section. If the clearance is too large, the rings or grooves are worn. If too small, metal may have been pushed into the grooves due to a piston seizure. Check that the grooves are not just carboned up. If new rings do not bring the clearance to the proper value, the pistons must be replaced.

2. To remove the rings from the piston, use a ring spreader as illustrated. They are available at most auto stores. Decarbonize the ring grooves.

3. To check the ring end-gap, ensure first



Removing piston rings with an expander makes breakage unlikely

that the cylinder bore is not excessively worn. Place each ring, in turn, into the bottom of its cylinder and push it in an inch or more using the piston skirt to align the ring in the bore. Measure the end-gap with a feeler gauge. If the end-gap is larger than the service limit, the rings must be replaced. If the measured end-gap of new rings is too large, the cylinder is worn and should be bored to the next oversize.

If new rings are fitted and the end-gap is too small, the ring ends must be filed. Hold the ring steady as illustrated, closing the ends over a thin, fine file. Do not squeeze the ring, as this is the easiest way to break it. A few strokes of the file will increase the end-gap.

**CAUTION:** Do not make more than a few strokes before checking the end-gap again. It is easy to remove too much metal.

Do not allow the file to slip out of the ring, as this risks breaking it.

4. Roll each ring around its own groove and ensure that this can be done easily. If a ring sticks or binds in the groove, the pistons must be replaced.

## Cylinder and Piston Installation

1. When installing piston rings, note that all rings are installed with the manufacturer's mark (the small letter near the end-gap) facing up.

**NOTE:** Oversize compression rings are

stamped "25" "50" "75" or "100" and must be fitted to the correct oversized piston. Oversized oil rings have painted expanders. Red is standard and the four oversizes are brown, blue, black, and yellow in ascending order.

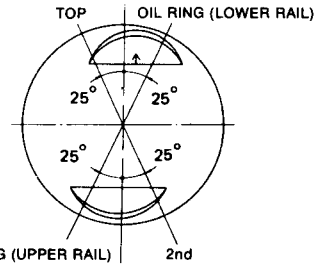

Stagger the ring end-gaps around the piston as shown

2. To install the three-piece oil ring, install one rail on the piston below the oil ring groove, fit the expander, then move the rail into place. Install the top rail.

3. Use a ring expander to install the rings to reduce the chance of breaking them.

4. Ring end-gaps must be staggered around the piston so that they do not overlap. Position the end-gaps as shown in the illustration. Note that none of the end-gaps are positioned at the very front or sides of the piston.

5. Install the pistons on their connecting rods so that the arrow marks on the crown face the front (exhaust side) of the engine.

**NOTE:** Be sure to use new wrist pin circlips.

6. Slip the wrist pins into place, heating the piston crown as on removal if necessary. Install the wrist pin circlips with a needle-nosed pliers. Be sure each circlip is firmly seated in its groove and arranged so that the circlip end-gap and the cut-out in the piston do not align.

7. Lubricate the rings and piston skirts with clean motor oil.

8. Install the o-ring on the oil delivery passage which is around the right rear stud.

9. Install the cylinder base gasket. Check that the cam chain is properly engaged with the crankshaft sprocket.

10. Install the cylinder, routing the cam chain up through its passage as the cylinders are lowered. Compress the piston rings with your fingers as the pistons enter the bores. Be sure the cylinders are firmly seated.

## Cylinder Head Installation

1. Be sure that the oil delivery passage o-ring is fitted to the right rear stud. Check that the dowel pins are fitted to the right and left front studs. Install the cylinder head gasket.

2. Fit the cylinder head over the studs and gradually lower it into position while pulling the cam chain through the cut-out.

3. Install and tighten the cylinder head bolts and nuts. Bolts should be torqued to 7 ft lbs, nuts to 24 ft lbs. Tightening should be done gradually and in a cross pattern beginning with the centermost nuts. Refer to the illustration showing tightening sequence. Lubricate the cam bearings on the head.

4. Pull up the cam chain and slip the cam through. Fit the cam sprocket, so that the

sprocket marks face the left side of the engine, and set the valve timing as described in the following steps.

**NOTE:** Using a new camshaft oil seal is recommended. Lubricate the seal lips before assembly.



Be sure the O-ring is in place around the right rear cylinder stud

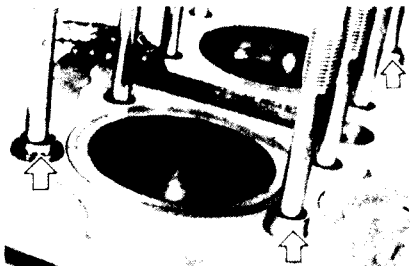

Install the O-ring and dowel pins on the cylinder studs

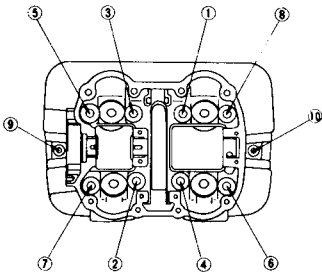

Tighten the cylinder head nuts and bolts in the order shown

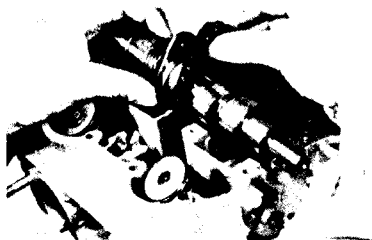

Installing the camshaft

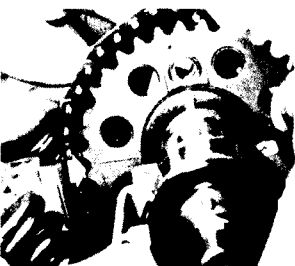

Install the cam sprocket so that the lines are flush with the head surface

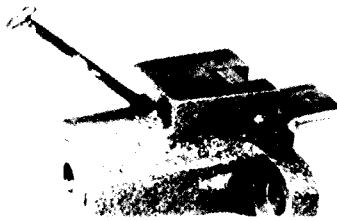

Use a pin to hold the cam chain tensioner spring in place

5. To set the cam timing, first turn the crankshaft so that the alternator rotor "LT" mark aligns with the timing mark.

6. Position the camshaft so that the locating pin faces upwards. Position the camshaft sprocket so that the two lines on the sprocket align with the cylinder head surface and the "O" mark on the sprocket is at the top.

7. Fit the cam chain over the sprocket without altering the sprocket's alignment.

8. The sprocket bolt holes should be aligned with the cam bolt holes at this point. Fit one of the cam sprocket bolts, tightening it to 13-16 ft lbs. Use a small quantity of a nonpermanent thread-locking compound on the bolt threads is recommended. Turn the engine over until the other bolt hole is acces-

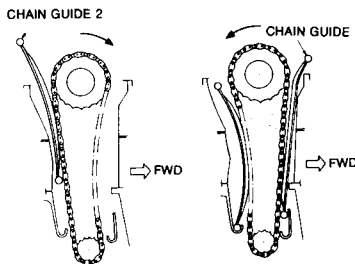

Rotate the crankshaft as shown to install the cam chain guides

sible, and fit that bolt, torquing it to the same value.

9. Thoroughly lubricate the cam lobes and bearings with motor oil.

10. Compress the cam chain tensioner spring and hold it in place with a pin inserted into the hole provided. Install the tensioner, tightening the bolts to 6-9 ft lbs. After properly tightening the bolts, remove the pin.

11. Fit the cam chain guides. It is necessary to rotate the crankshaft to do this, as this will slacken one side or the other of the chain to allow the guides to be slipped into place.

12. If the rocker arms have been disassembled, lubricate the arms and shafts thoroughly and install them in the head cover. Note that the threaded end of the shafts must face outwards. Use new o-rings.

13. Use a liquid gasket on the head cover mating surface, then install the cover. Tighten the head bolts gradually and in a cross pattern.

Proper torque is 6-9 ft lbs. for the 6 mm bolts and 15-17 ft lbs. for the 8 mm bolts.

14. Install and secure the rocker arm shaft plugs.

15. Adjust the valve clearance.

16. Carefully turn the engine over to ensure that the valve timing is correct. If resistance is felt when turning the crankshaft, stop immediately and determine the cause. Do not force the crankshaft or bent valves may result.

17. On breaker point models, install the timing advance mechanism, being sure to engage the hole in the mechanism with the pin on the camshaft. Tighten the bolt to 6-9 ft lbs. Fit the breaker point plate. The lead wires pass beneath the top cooling fin. Adjust the ignition timing after assembly is completed.

18. On transistor ignition models, install the pick-up coil assembly. Install the rotor and tighten the rotor bolt to 7 ft lbs. Check the ignition timing. If it is not correct, rotate the pick-up coil base until the timing marks align at the specified rpm as outlined in chapter 3. After fitting the pick-up coil cover, install a new blind plug. Do not force the plug in against determined resistance, or the cover may be cracked.

## CRANKCASE COVER COMPONENTS

The following sections deal with the removal, inspection, and installation of those components found beneath the left and right crankcase covers. These include the clutch, alternator, starter drive, shift mechanism, kickstarter, and engine sprocket. These components can be serviced with the engine in the frame.

Note the following points:

a. Crankcase covers are secured with allen screws. When installing these screws, coat the threads with a bit of lubricant or antiseize paste to facilitate future removal. Tighten the screws evenly.

b. New cover gaskets (where applicable) should always be used. Remove any traces of old gasket or gasket sealing compound from the cover and crankcase mating surface.

c. During the disassembly procedure it may be necessary to keep the engine from turning over while a component is removed. There are several ways to do this. If the engine is in the frame, place the transmission in gear and apply the rear brake. If the engine has been removed from the frame, loop a length of old drive chain around the engine sprocket and secure the end in a vise. Engage the transmission and the engine will not turn over.

## Clutch REMOVAL

1. Drain the oil.
2. Remove the right-side exhaust system, the rider's footpeg, and the rear brake pedal.
3. Unscrew and remove the right crankcase cover bolts. Remove the cover. If it is stuck, tap around the cover with a plastic mallet until it is freed.
4. Gradually, and in a cross-pattern, unscrew and remove the clutch pressure plate screws. Remove the springs, the pressure

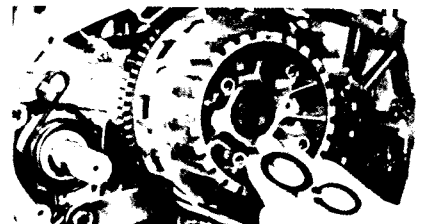

Clutch hub circlip and thrust washer

# Yamaha XS360-400

plate, and the steel and friction plates. Note the order of the steel and friction plates.

- Remove the pushrod.
- Remove the clutch hub circlip, thrust washer, and remove the clutch hub.
- Remove the clutch housing, noting any thrust washers on the engine or hub side of the housing.

## INSPECTION

1. Check the condition of the kick-start shaft oil seal. If it leaks, or if the lips show signs of damage, pry the old seal out with a small screwdriver. Press the new seal straight into the cover. Apply some oil or grease to the seal lips before installation.

2. Check the condition of the clutch cover mating surface. Remove any burrs or imperfections with an oilstone.

3. Measure the thickness of the friction plates, and replace them if they are less than 2.7mm (0.106 in.) thick.

4. Place the steel clutch plates on a flat surface, such as a piece of glass, and check for excessive warpage by attempting to slip a feeler gauge blade between the surface and the plate. Replace the steel and friction plates as a set if warpage exceeds 0.05 mm (0.002 in.).

5. Measure the free-length of each clutch spring and replace them as a set if any are found to be less than 34.6 mm (1.36 in.) long, or if their length varies. If the latter is true, be sure that all of the screws are evenly tightened on assembly.

6. Check the friction plate tabs for wear or damage. Check the clutch housing for indented wear caused by the tabs. Remove any burrs with a file or oilstone.

7. Check the corresponding splines of the clutch hub and steel plates for indented wear.

8. Using a dial indicator, check the pushrod for a bent condition. Replace the pushrod if it is bent more than 0.2 mm (0.008 in.).

9. Check the condition of the clutch gear teeth. Note any pitting or chipping. Check the primary gear teeth as well. If damage to either is noted, replace both. The primary gear is replaced by removing the securing bolt and pulling off the gear.

10. Note the lash letters stamped on the clutch gear and primary gear. The gears

should be replaced with reference to these lash letters. Gears should be paired as follows:

Primary gear	Clutch gear
A	C
B	D
C	E
D	F

## INSTALLATION

1. Installation is the reverse of disassembly. When fitting the clutch plates, alternate steel and friction plates. The last plate installed should be a friction plate.

2. Install the pressure plate so that the arrow on the plate aligns with the arrow on the clutch hub.

3. Tighten the pressure plate screws gradually and evenly.

4. Tighten the primary gear bolt to 29–33 ft lbs.

## Kickstarter Shaft

### REMOVAL

1. After removing the right crankcase cover, the kickstarter shaft can be removed by pulling it out.

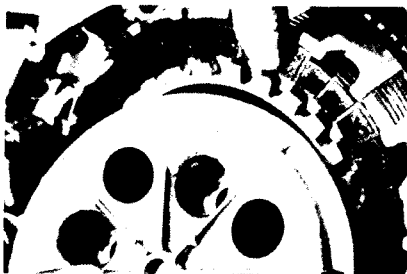

When installing the pressure plate, align the arrow on the plate with that on the clutch hub

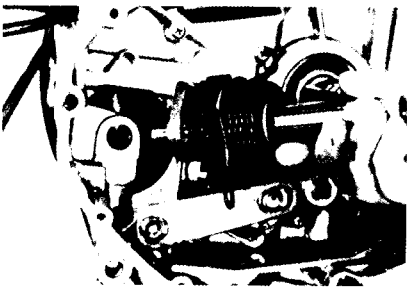

Removing the kickstarter assembly

2. When disassembling the shaft components, lay each one out in the order removed to facilitate assembly.

### INSPECTION

1. Check the condition of the kickstarter shaft splines.

2. Check the kickstarter gear teeth for chipping or other damage, and replace it if such damage is noted.

3. Check the condition of the shaft return spring. The spring should be replaced if it will not return the shaft quickly to the rest position and hold it securely in place.

### INSTALLATION

1. Set the kickstarter gear clip into the groove in the crankcase.

2. Rotate the return spring clockwise and hook it onto the projection.

## Gearshift Mechanism

### REMOVAL

1. Remove the right crankcase cover. Remove the clutch assembly.

2. Remove the engine sprocket cover (left side).

3. Remove the circlip from the gearshift shaft on the left side of the engine and pull out the gearshift assembly from the right.

### INSPECTION

1. Check the gearshift shaft for a bent condition and replace it if it is bent. Check the condition of the gearshift shaft splines.

2. Check the condition of the shift fingers. Note any chipping or wear to the finger ends. Replace the fingers if they are bent or worn.

3. Inspect the shift mechanism springs and replace them if weakened or broken.

### INSTALLATION

1. Installation is the reverse of removal. After fitting the mechanism, temporarily install the gearshift lever and test shifting action through the gears.

2. In each gear, check that the shift fingers are equidistant from the shift drum pins. Refer to the illustration. If they are not, loosen the adjusting screw locknut and turn the screw to equalize the distances. Use a non-permanent thread-locking compound on the adjusting screw after the adjustment is correct. Do not forget to tighten the locknut.

3. Check for freeplay in the gearshift lever. There should be none. If any is evident, the return spring is evidently weakened and should be replaced.

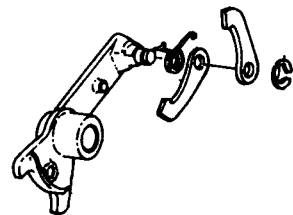

Gearshift assembly

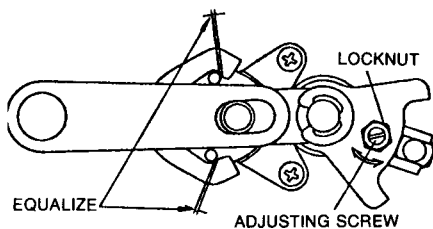

Use the adjusting screw to equalize the two clearances indicated

4. Check that the shift finger return spring will hold the fingers firmly against the shift drum pins. If not, replace the spring.

## Oil Pump

Refer to "Lubrication System," for oil pump removal, inspection, and installation procedures.

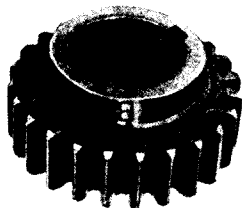

Primary gear lash notation

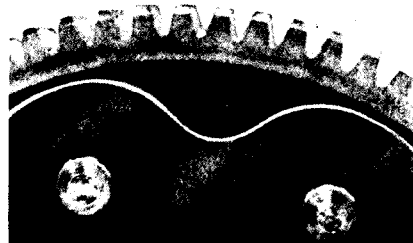

Clutch gear lash letter location



## Engine Sprocket

### REMOVAL

1. Remove the left-side rider's footpeg. Remove the gearshift lever.
2. Remove the engine sprocket cover screws and take off the cover.
3. Place the transmission in gear and apply the rear brake. Unscrew and remove the engine sprocket nut. Remove the lock-washer and sprocket. It may be necessary to move the rear wheel forward to remove the sprocket from its shaft.

### INSTALLATION

Installation is the reverse of removal. Tighten the sprocket nut to 36–58 ft lbs.

## Alternator/Starter Drive

### REMOVAL

1. Drain the crankcase oil.
2. Remove the alternator cover.
3. Remove the rotor bolt. Remove the rotor with the special puller. Take out the woodruff key.
4. Remove the sprocket guide and chain guide.
5. Pull off the starter and crankshaft sprocket and chain.

### INSPECTION

1. Check the sprockets for wear such as hooking of the teeth. Replace them, along with the chain, as necessary.

### INSTALLATION

Installation is the reverse of removal. The alternator rotor must be turned onto its shaft because of the starter clutch rollers.

Tighten the rotor bolt to 22–25 ft lbs.

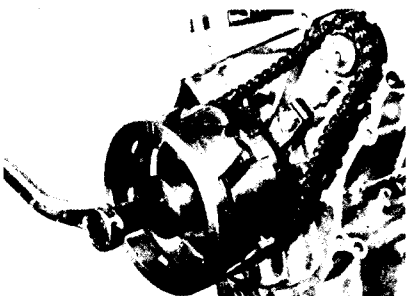

Removing the alternator rotor

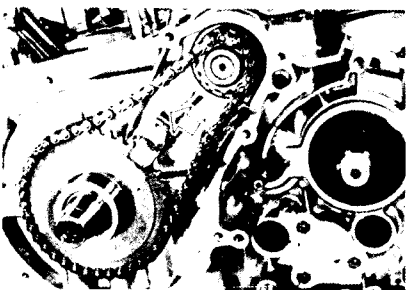

Starter drive

## LOWER END AND TRANSMISSION

### Splitting the Crankcases

Splitting the crankcases is necessary for service to the crankshaft and connecting rods, transmission gears, and internal shift mechanism.

Removal of the engine is required.

1. Drain the oil. Remove the engine from the frame.
2. Remove the top end components.
3. Remove the left and right crankcase covers and the components therein: clutch, primary drive gear, kickstarter shaft, oil pump assembly, gearshift mechanism, engine sprocket, alternator/starter drive assembly, etc.
4. Remove the starter motor. Remove the breather cover.
5. Disconnect the neutral switch lead and the oil pressure switch lead.
6. Remove the neutral switch cover.
7. Remove the shift drum cam stopper plate and the change lever guide (right side).

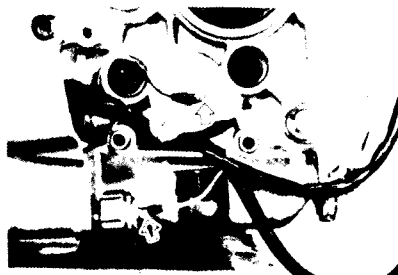

Neutral and oil pressure switch leads



Removing the neutral switch cover

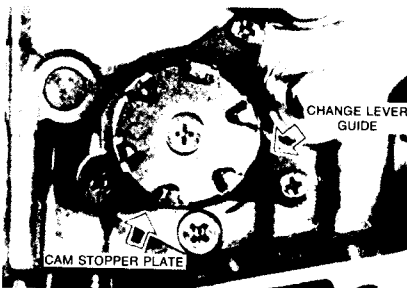

8. Remove the upper and lower crankcase bolts. Loosen each bolt 1/4 turn, then remove all of them.

9. Remove the upper crankcase half. If it is stuck, first check that all fasteners have been removed. Then tap around the case mating surface with a plastic mallet to break the case free.

## Case Assembly

1. Be sure that the crankcase mating surface is clean and free of all traces of old gasket compound. Minor scratches or burrs can be

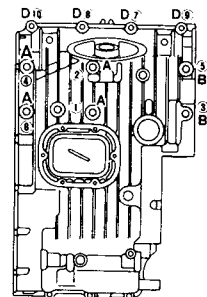
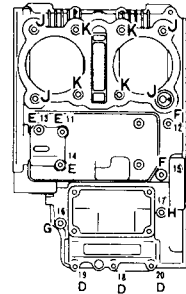

Crankcase bolt locations

removed with an oilstone, although care must be taken that the surface is not grooved when doing this.

2. Lubricate all bearing surfaces with motor oil.

3. Be sure that the crankshaft and transmission shafts are properly seated. The transmission shaft bearings are located with set rings. Be sure the shift forks are engaged with their gears.

4. Be sure that all dowel pins between the cases are in place.

5. Apply a thin coat of a liquid gasket compound to the case mating surface. Install the upper case half. After ensuring that it is properly seated, install the crankcase bolts and tighten them gradually and in a cross pattern.

Tighten the 8 mm bolts to 15–17 ft lbs.

Tighten the 6 mm bolts to 6–9 ft lbs.

## Transmission/Gear Shift Assembly

### REMOVAL

1. Lift the transmission shafts out of the case.
2. Before removing the shift forks, mark

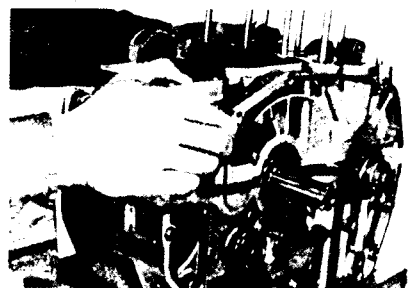

Separating the crankcase halves

# Yamaha XS360-400



Removing the shift fork shaft circlip

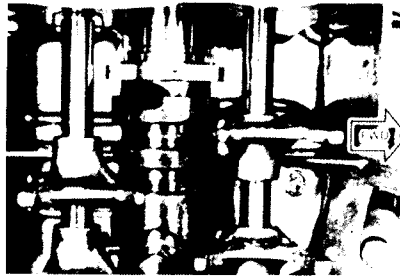

Shift fork installation

exceeds 0.02 mm (0.0008 in.), the crank is bent and must be replaced.



Checking the crankshaft for run-out



Removing the shift drum cam plate circlip

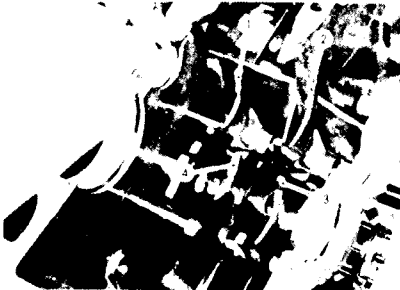

After installing the shift forks (1-4), be sure that the transmission shaft bearing set rings are in place

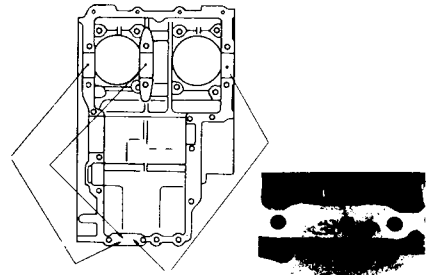

Crankshaft bearing insert number locations

them so that they can be installed in their original locations.

3. Remove the shift fork shaft circlips and push out the shafts with grommets.

4. Move the shift drum as far as possible to one side, then remove the cam plate circlip and the cam plate. Remove the shift drum.

## INSPECTION

**NOTE:** Do not disassemble the gear set unless inspection shows that replacement of individual gears is necessary. Gear shaft circlips are not reusable and must be replaced with new ones whenever the gear set is taken apart.

If the gear set is disassembled, carefully lay out each piece in the order it is removed to facilitate reassembly.

1. Flush the transmission shaft bearings with clean motor oil and check operation. Bearing rotation must be smooth, effortless, and quiet. There must be no play between the inner and outer bearing races. If damage is noted, replace the bearings as a set.

2. Check the gear teeth for damage, wear, or pitting. Pay close attention to the very base of the teeth. Gears are surfacehardened, and if this hardened layer is damaged, what is left will not last long. Check the engaging dogs and/or dog slots on each gear for chipping or wear. Check that splined gears are a good fit on their shaft (neither too loose nor too tight) and that the splines on the shafts and on the gears are in good condition. Check that gears with plain bores can rotate freely but are not too loose on their shafts.

Check all parts for damage due to overheating or lack of lubricant.

**NOTE:** Gears should always be replaced in pairs.

3. Check that the gear shift fork fingers are not chipped, worn, or bent. If any damage is noted, replace the shift fork in question.

4. Check that each shift fork moves freely on its shaft. If sticking or binding is noted, determine the cause. Check the shafts for a bent condition. Replace any shafts which are even slightly bent.

5. Check the shift fork guide pins for wear. Also inspect the corresponding grooves in the shift drum.

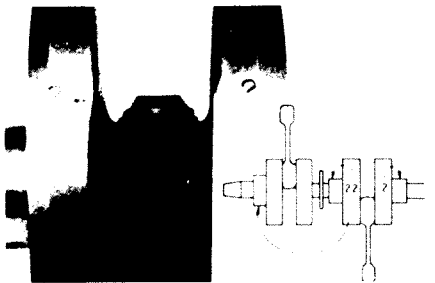

Crankshaft bearing insert number locations on the crank flywheels

## ASSEMBLY

1. Assemble the gear sets onto their shafts. Use new circlips.

2. Install the shift drum, fitting the cam plate on the drum as illustrated.

3. Install the shift forks, shafts, and grommets.

4. Be sure that the bearing locater rings are in place in the crankcase.

5. Use new oil seals. Install the output shaft oil seal on the shaft before installation.

6. Install the transmission shafts, engaging the shift fork fingers with the proper gears as this is done. Assembly is facilitated by ensuring that the transmission is in neutral.

7. Install the shift drum cam stopper plate and the change lever guide. Use a non-permanent thread-locking compound on these screws.

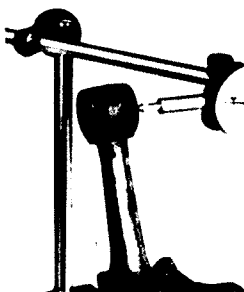

Checking big end axial play

2. Check the crankshaft bearing inserts in the crankshaft for scoring or obvious signs of wear and replace the inserts if the surfaces are not in good condition. The inserts must be free of any defects or they should be replaced.

3. Crankshaft bearings are replaced as a set, and the correct color insert should be selected. Replace bearing inserts with others of the same color. If the color of the old bearing is no longer visible, refer to the following chart:

Note the crankcase number which is stamped on the case and the crank journal number inscribed on the crank flywheel. Compare the two numbers to select the proper bearing insert.



Install the cam plate on the shift drum as shown

# Yamaha XS360-400

Crankcase No.	Journal No.	Insert
3	1	Blue
4	2	Black
5	-	Brown
-	-	Green

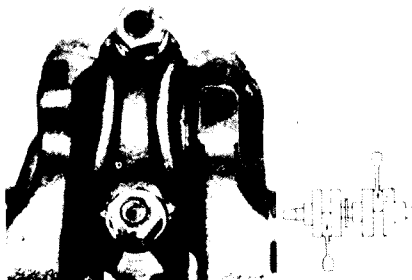

Big end bearing insert number location



Be sure that both rods have the same identification numbers and that the numbers on rods and caps align

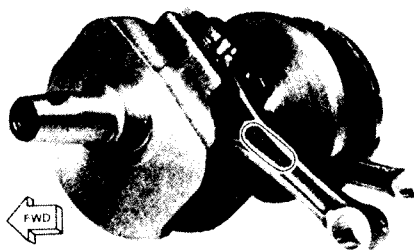

When installing the rods, be sure that the "YAMAHA" mark faces the left side of the crank

4. With a dial gauge, check connecting rod side play at the small end. If the movement exceeds 0.5 mm (0.019 in.), the big end bearing should be replaced.

5. Replace big end bearing inserts with inserts of the same color code. If the color is no longer visible on the old insert, select a replacement according to the following chart.

Big End Bearing No.	Crankpin No.	Insert
3	1	Blue
4	2	Black
5	-	Brown
-	-	Green

6. If one or both of the connecting rods is going to be replaced, be sure that the weight codes stamped on the rod and cap match for both rods.

7. Before installing connecting rods on the crankpins, thoroughly lubricate the bearings with motor oil. Install the rods so that the "YAMAHA" mark on both rods faces the left end of the crankshaft and the bearing protu-

berance is towards the intake side of the engine. Be sure that the rods are installed so that the cap numbers align with the rod numbers.

8. Coat the con rod bolt threads with a molybdenum disulphide lubricant and torque them to 24–28 ft lbs.

## Engine Specifications XS360

### CYLINDER

Bore	66.00–66.02 mm/2.5900–2.5908 in.
Max allowable taper	0.05 mm/0.002 in.
Max allowable out-of-round	0.01 mm/0.0004 in.

### PISTON

Piston skirt-to-cylinder clearance	0.030–0.050 mm/0.0012–0.0019 in.
Piston oversizes	66.25 mm/2.608 in. 66.50 mm/2.618 in. 66.75 mm/2.628 in. 67.00 mm/2.638 in.
Wrist pin diameter	15.995–16.000 mm/0.6298–0.6300 in.

### PISTON RINGS

Piston ring end-gap (installed)	0.2–0.4 mm/0.008–0.016 in.
Compression	0.2–0.9 mm/0.008–0.035 in.
Oil	
Groove side clearance	
Top compression	0.04–0.08 mm/0.0016–0.0032 in.
Lower compression	0.03–0.07 mm/0.0012–0.0028 in.

### CAMSHAFT

Bearing clearance	0.020–0.054 mm/0.00079–0.00213 in.
Intake lobe height service limit	38.70 mm/1.527 in.
Exhaust lobe height service limit	38.74 mm/1.525 in.
Intake lobe base circle service limit	32.08 mm/1.263 in.
Exhaust lobe base circle service limit	31.90 mm/1.256 in.
Max allowable run-out	0.03 mm/0.0012 in.

### ROCKER ASSEMBLY

Rocker arm bore diameter	13.000–13.018 mm/0.5120–0.5127 in.
Rocker arm shaft diameter	12.964–12.984 mm/0.51199859–0.51199937 in.
Shaft-to-bore clearance	0.016–0.054 mm/0.00063–0.00122

### VALVES

Valve seat width	1.0–1.1 mm/0.03937–0.04330 in.
Intake valve stem diameter	6.975–6.990 mm/0.2741–0.2746 in.
Exhaust valve stem diameter	6.955–6.970 mm/0.2732–0.2738 in.
Valve-to-stem clearance	
Intake	0.010–0.037 mm/0.00039–0.00145 in.
Exhaust	0.030–0.057 mm/0.0012–0.0022 in.
Max allowable run-out	0.03 mm/0.0012 in.

### VALVE SPRINGS

Free length	
Inner	39.3 mm/1.547 in.
Outer	42.8 mm/1.685 in.
Tilt replacement limit	
Inner	1.7 mm/0.067 in. (2.5°)
Outer	1.9 mm/0.075 in. (2.5°)

### CRANKSHAFT

Max allowable run-out	0.02 mm/0.0008 in.
Crank bearing clearance	0.020–0.044 mm/0.00079–0.00157 in.
Con rod big end clearance	0.021–0.045 mm/0.00080–0.00180 in.

## Engine Specifications XS400

### CYLINDER

Bore	69.00–69.02 mm/2.7200–2.7208 in.
Max allowable taper	0.05 mm/0.002 in.
Max allowable out-of-round	0.01 mm/0.0004 in.

### PISTON

Piston skirt-to-cylinder clearance	0.030–0.050 mm/0.0012–0.0019 in.
Piston oversizes	69.25 mm/2.727 in. 69.50 mm/2.736 in. 69.75 mm/2.746 in. 70.00 mm/2.756 in.
Wrist pin diameter	15.995–16.000 mm/0.6298–0.6300 in.

### PISTON RINGS

Piston ring end-gap (installed)	0.2–0.4 mm/0.008–0.016 in.
Compression	0.2–0.9 mm/0.008–0.035 in.
Oil	
Groove side clearance	
Top compression	0.04–0.08 mm/0.0016–0.0032 in.
Lower compression	0.03–0.07 mm/0.0012–0.0028 in.

### CAMSHAFT

Bearing clearance	0.020–0.054 mm/0.00079–0.00213 in.
Intake lobe height service limit	39.38 mm/1.550 in.
Exhaust lobe height service limit	39.42 mm/1.552 in.
Intake lobe base circle service limit	32.12 mm/1.265 in.
Exhaust lobe base circle service limit	31.97 mm/1.259 in.
Max allowable run-out	0.03 mm/0.0012 in.

# Yamaha XS360-400

## INSTALLATION

Lubricate the crank and rod bearings thoroughly before installation.

### Engine Torque Specifications

Part	Torque (ft lbs)
Cylinder head	
10 mm	22-25
6 mm	6-9
Tappet cover	7-10
Rocker arm plug	9-15
Spark plug	13-16
Connecting rod bolts	24-28
Valve adjusting screw	9-11
Cam sprocket bolts	13-16
Oil filter housing bolt	10-12
Exhaust pipe ring nut	15-17
Crankcase bolts	
8 mm	15-17
6 mm	6-9
Oil drain bolt	25-29
Primary gear	29-33
Engine sprocket	36-58
Alternator rotor bolt	21-25
Oil pressure switch	7-11
Neutral switch	2-3
Shift drum stopper	9-15

## Engine Specifications (cont.) XS400

### ROCKER ASSEMBLY

Rocker arm bore diameter	13.000-13.018 mm/0.5120-0.5127 in.
Rocker arm shaft diameter	12.964-12.984 mm/0.51199859-0.51199937 in.
Shaft-to-bore clearance	0.016-0.054 mm/0.00063-0.00122

### VALVES

Valve seat width	1.0-1.1 mm/0.03937-0.04330 in.
Intake valve stem diameter	6.975-6.990 mm/0.2741-0.2746 in.
Exhaust valve stem diameter	6.955-6.970 mm/0.2732-0.2738 in.
Valve-to-stem clearance	
Intake	0.010-0.037 mm/0.00039-0.00145 in.
Exhaust	0.030-0.057 mm/0.0012-0.0022 in.
Max allowable run-out	0.03 mm/0.0012 in.

### VALVE SPRINGS

Free length	
Inner	39.3 mm/1.547 in.
Outer	42.8 mm/1.685 in.
Tilt replacement limit	
Inner	1.7 mm/0.067 in. (2.5°)
Outer	1.9 mm/0.075 in. (2.5°)

### CRANKSHAFT

Max allowable run-out	0.02 mm/0.0008 in.
Crank bearing clearance	0.020-0.044 mm/0.00079-0.00157 in.
Con rod big end clearance	0.021-0.045 mm/0.00080-0.00180 in.

## LUBRICATION SYSTEM

### OPERATIONAL DESCRIPTION

The oil pump is housed beneath the right crankcase cover and is driven by the crankshaft through a reduction gear. The pump is the "trochoidal" type, meaning that it consists of one rotor turning inside another. The shape of the rotors gives the pump its name and the action of one working against the other pumps the oil.

The oil pump sucks oil from the sump. The oil passes through a coarse wire-mesh filter before reaching the pump, which removes any large impurities which might damage the pump rotors. This filter is made coarse so as not to restrict the passage of oil in low temperatures.

The oil pressure relief valve is fitted in conjunction with the pump. The relief valve is pre-set to operate at a pressure above about 70 psi. If the oil pressure reaches this value, the relief valve opens and returns some of the oil to the sump.

After passing through the oil pump, the oil is forced through the replaceable oil filter where microscopic impurities are removed. The oil filter housing is equipped with a by-pass valve. In the event that the filter becomes clogged with filtered material, oil will flow around it to reach the engine's mov-



Oil pressure gauge fitting

ing parts. This oil, however, will not be filtered, so it is imperative to change the filter at the prescribed intervals to ensure long engine life.

After leaving the filter, the oil enters the main oil gallery. Here, oil passages allow it to be fed directly to the crankshaft main bearings, connecting rod bearings, and transmission shafts. An oil passage running up through the cylinders and head feeds oil to the camshaft and valve assemblies. The main oil passage is also equipped with an oil pressure switch which monitors the system for pressure failure, and it includes a fitting to attach an oil pressure gauge.

After lubricating the various components, the oil is returned to the sump and the cycle is repeated.

### CHECKING OIL PRESSURE

1. A special gauge is needed to check the oil pressure. It is attached to a fitting on the left side of the crankcase sump (see illustration).

2. Oil pressure should be checked when the engine is at operating temperature. Before checking, be sure that the oil level is between the two dipstick marks.

3. At 3,000 rpm, the oil pressure should be about 42 psi (3 kg/cm<sup>2</sup>).

4. If the pressure is significantly lower than this, remove and inspect the oil pump. If the oil pump condition is satisfactory, the lack of oil pressure may be caused by worn or damaged bearings.

### OIL PUMP

#### Removal

1. Drain the oil.
2. Remove the kickstarter pinch bolt and carefully pull the kickstarter off the splined shaft.
3. Remove the right-side footpeg and the rear brake pedal.
4. Remove the allen bolts which secure the right side crankcase cover and take off the cover. If the cover is stuck, tap around the sides with a plastic mallet to free it. Pull the cover straight off and do it carefully to avoid damage to the kickstarter shaft oil seal.
5. Remove the three allen bolts which hold the oil pump and pump gear and take off the assembly.

#### Inspection

1. Carefully loosen and remove the three phillips screws which secure the oil pump rotor cover plate. Remove the plate.
2. Measure the clearance between the rotor tips with a feeler gauge. The specified

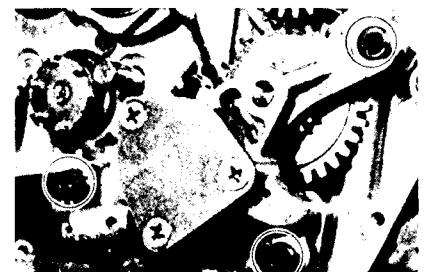

Oil pump assembly allen bolts

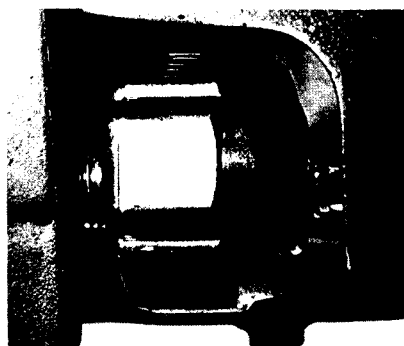

Oil pressure switch location

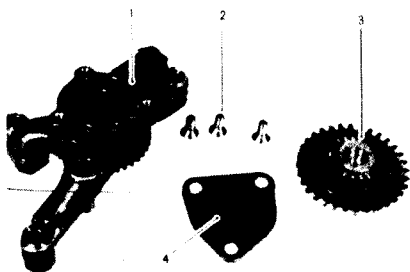

Oil pump (1), cover screws (2), drive gear (3), and cover (4)

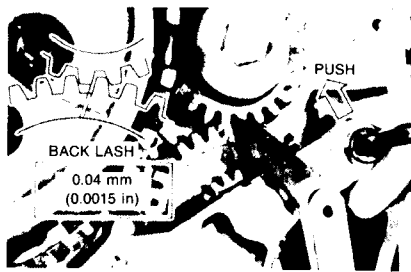

Adjusting the gear backlash

measured clearance is greater than this, replace the rotors.

5. The rotors have match marks on one side. If the pump is disassembled, be sure that the rotors are installed so that the match marks line up.

6. Use a small amount of a non-permanent thread-locking compound on the oil pump rotor cover plate.

## Installation

1. Installation is the reverse of removal. The primary gear-pump idler gear backlash must be adjusted.

2. Fit the oil pump assembly and install, but do not tighten, the mounting bolts. Measure the clearance between the primary gear and the oil pump idler gear. It should be 0.04 mm (0.0015 in.). To obtain the correct backlash push or pull on the oil pump assembly. When clearance is correct, hold the assembly in place and tighten the mounting bolts securely.

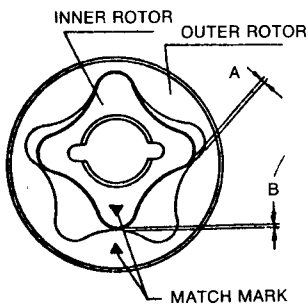

Rotor tip clearance (A,B) and rotor match marks

clearance is 0.03–0.09 mm (0.0012–0.0035 in.). If the measured clearance is not within this specification, replace the rotors.

3. Measure the clearance between the outer rotor and the oil pump housing. Specified clearance is 0.03–0.09 mm (0.0012–0.0035 in.). If the measured clearance exceeds this amount, replace the rotors or housing.

4. Lay a straight edge across the top of the rotors and measure the side clearance with a feeler gauge. Side clearance should be 0.010–0.18 mm (0.0039–0.0071 in.). If the

## Lubrication System Specifications

Oil pump type	Trochoid
Rotor side clearance	0.10–0.18 mm (0.0039–0.0071 in.)
Rotor tip clearance	0.03–0.09 mm (0.0012–0.0035 in.)
Outer rotor-to-pump body clearance	0.03–0.09 mm (0.0012–0.0035 in.)
Pump output	1.2 l (1.3 qt) per minute @ 500 rpm
Relief valve operating pressure	5 kg/cm <sup>2</sup> (71 psi)
Filter by-pass valve operating pressure	1 kg/cm <sup>2</sup> (14 psi)

## FUEL SYSTEM

### CARBURETORS

#### Removal

1. Disconnect the fuel line at the petcock. Disconnect the petcock vacuum line at the right manifold.

2. Lift the seat. Remove the gas tank bolt. Lift up the rear of the tank and slide it back until it is clear of its rubber mounts. Remove the gas tank from the motorcycle.

3. Disconnect the throttle cable from the lever between the carburetors.

4. Loosen the screws on the manifold clamps and the air cleaner hose clamps.

5. Carefully pull the carburetors back until they are free of the manifolds, then move them out to the side and off the motorcycle.

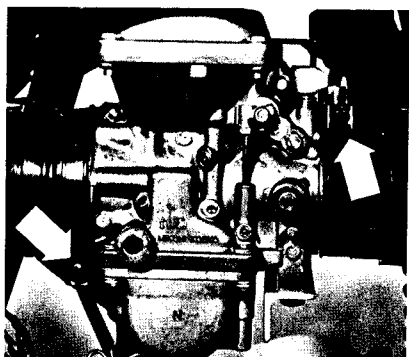

Carburetor manifold and air cleaner hose clamp screws



Petcock vacuum line connection



Removing the carburetors

#### Installation

1. Installation is basically the reverse of removal.

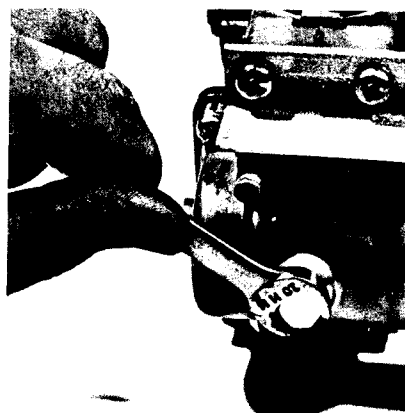

Removing the drain plug

2. Position the carburetors on the manifolds and be sure they are properly seated. Work the air cleaner hoses around the carburetor mouths and be sure they are not folded or creased. Tighten the clamps. Connect the throttle cable. Check twist-grip action.

3. After fitting the gas tank and connecting the lines, turn the petcock to the "Prime" position for a few moments to fill the float bowls. Check for leaks before starting the motorcycle.

# Yamaha XS360-400

## Disassembly

1. Remove the drain plug at the bottom of each float bowl. Holding the carburetors in the normal operational position, allow the gas to drain off. Refit the drain plugs to prevent loss.

2. Remove the angle-iron bracket which runs by the float bowls and holds the carburetors together.

3. Loosen the choke rod securing screws and disconnect the choke rod from the starter plungers. Pull out the rod. Take care that the shaft positioning balls on the left and right do not pop out.

4. Remove the bracket which holds the carburetors together at the caps.

5. Separate the two carburetors.

6. Remove the carburetor cap. Take out the return spring. Carefully, so as to avoid damage to the rubber diaphragm, lift out the throttle slide assembly.

7. Remove the float bowl screws and carefully lift off the float bowl until it clears the floats. If the bowl is stuck, rap it once on the side with the screwdriver handle. This should be sufficient to break it free.

8. Using a small punch, push out the float pivot pin and remove the float bulbs.

9. Lift out the float needle.

10. Unscrew and remove the float needle seat and gasket.

11. Unscrew and remove the pilot and main jets. On XS360 models, these are fitted to the float bowl, but on the 400 they are on

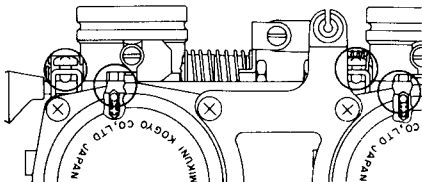

Choke shaft securing screw and plunger location



Carburetor top and throttle slide assembly



Removing the float bowl screws

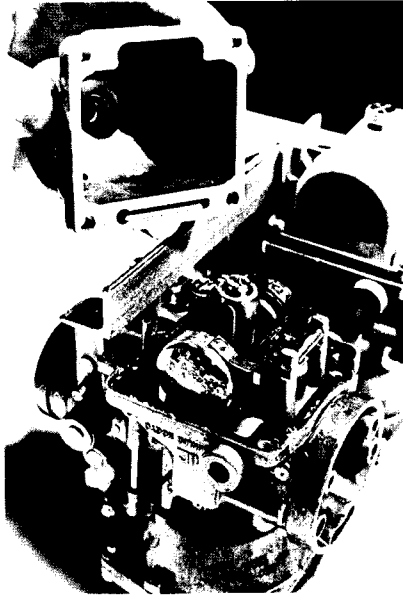

Removing the float bowl

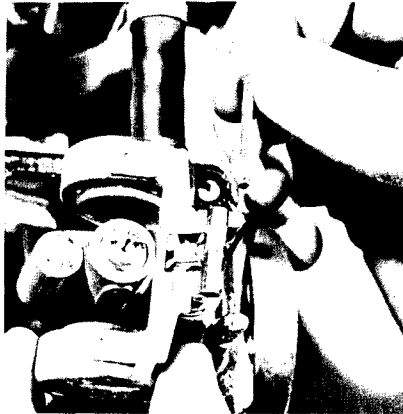

Removing the float assembly



Removing the float needle

the carburetor body. Jets are brass and should be removed carefully to avoid damage.

12. Pry out the washer beneath the needle jet, and remove this jet by tapping it out with a wooden dowel or the like from the top of the carburetor.

13. Remove the float bowl gasket.

14. Remove the banjo bolt for the fuel feed line from the left carburetor.

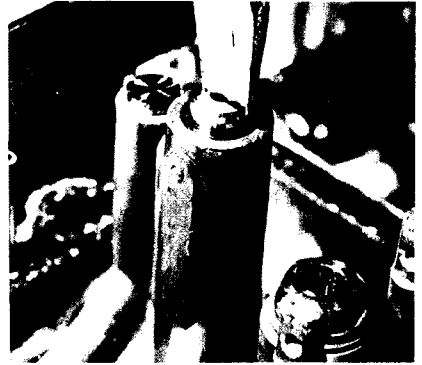

Unscrewing the main jet

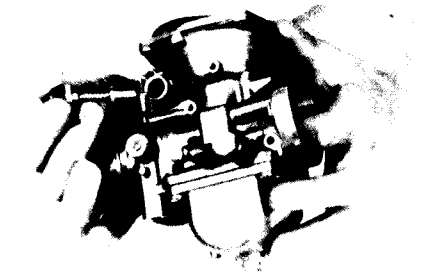

Removing the plunger assembly

15. Remove the idle limiter caps from the pilot screws and remove the screws.

16. Unscrew and remove the starter plunger from the carburetor.

## Inspection

1. Clean the carburetor body and float bowl in a carburetor cleaner or solvent which is safe for plastic parts and dry thoroughly.

2. Use compressed air to blow air and fuel passages clear.

3. Clean all fuel jets in the same manner.

**CAUTION:** Do not insert anything into the jet passages to clear them; use air pressure only.

4. Inspect the carburetor body for any vibration or stress cracks.

5. Check the condition of the throttle slide. Smooth movement of the slide on the carburetor body is imperative. If the slide sticks or binds at any point from full closed to wide open, replace it.

6. Inspect the needle jet and the needle. The needle must be free of nicks or score marks along its tapered portion. More often, however, these components will need to be replaced because of normal wear. As the throttle slide moves up and down while the machine is in operation, the needle is rubbing against the jet. Eventually, these components will wear enough to cause a noticeable rich running condition in the mid-throttle range. If this occurs, both the needle and the jet should be replaced. If the components are more than four years old, new ones should be fitted before attempting to tune the carburetor, or taking remedial action to correct a rich condition (such as lowering the needle).

7. Carefully inspect the float. Shake the float close to your ear; listen for any gasoline trapped inside. If the float assembly leaks, or if any puncture is noted, replace it; do not attempt repairs.

8. Inspect the tip of the float needle and the needle seat for dirt or corrosion. Check the needle tip for wear. If worn, the needle should be replaced.

If there is any corrosion or deposits evident on the needle or needle seat, the deposits must be removed, or the parts replaced.

**NOTE:** Do not attempt to clean the needle or needle seat by lapping one against the other.

To check the efficiency of the float needle valve, proceed as follows:

a. With the carburetor assembled except for the float bowl, connect it to its fuel line;

b. Place a number of dry rags beneath the carburetor, and hold it upright (in its normal operating position) with one hand;

c. With the other hand, gently raise the float assembly until the float needle is seated. Have an assistant turn the fuel petcock on ("Prime" position);

d. If the needle and seat are in good condition and forming a good seal, no gasoline will flow out of the carburetor;

e. If a leak is noted, replace the needle and seat.

**CAUTION:** While performing this test, be sure that adequate precautions are taken in the event of spillage.

The float level should be checked prior to assembly.

9. Check that the tapered portion of the pilot screw is smooth and clean. Replace it if it is crushed or blunted.

10. Inspect the float bowl for a warped gasket surface, or stress cracks (especially around the screw holes).

11. Check the throttle slide diaphragm for rips. Replace the assembly if the diaphragm is damaged. Repairs are not possible.

3. If the throttle slide and needle have been disassembled, check that both needle clips are installed in the correct groove from the top of the needle. Refer to the "Carburetor Specifications" chart at the end of this section for the correct needle clip position.

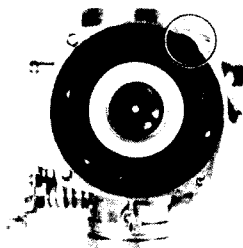

Be sure that the diaphragm tab is properly seated

4. When installing the pilot screws, turn them in gently until they are lightly seated, then back them out 1½ turns on XS360 models and 1¼ turns on XS400 models. Fit the idler limiter caps.

5. When fitting the throttle slide, be sure to engage the tab on the diaphragm with the cut-out in the carburetor body.

6. Check the float level as outlined in the "Tune-Up" section.

7. When installing the choke rod, be sure that the securing screws fit into the shaft detents.

## FUEL PETCOCK

The petcock is the vacuum-activated type which incorporates a mesh filter inside the gas tank.

1. Set the petcock to the "RES" position. Disconnect the fuel line from the manifold and the vacuum line from the manifold.

2. Remove the gas tank. Drain off the fuel.

3. Unscrew the petcock securing nut or two phillips screws depending upon the method of fastening, and pull off the petcock.

4. Clean the filter screen in a solvent. Be sure to remove any foreign matter trapped in the screen as this will impede fuel flow. If the screen cannot be cleaned, or if it is punctured or otherwise damaged, it should be replaced.

5. Check the sealing washer and replace it if it is damaged.

6. Install the petcock. After the tank is refitted, check for leaks before operating the motorcycle.

7. Check operation of the petcock after disconnecting the fuel feed line. No fuel should flow out when the lever is in the "On" or "RES" positions. This should happen only when the lever is set to the "Prime" position. If fuel does flow in the other positions, replace the petcock.

8. In the event that fuel flow is a problem, check that the vacuum line is tightly secured at both ends, and is free from dry-rotting or other damage. Replace the vacuum line if any damage is noted.

## Carburetor Specifications

	XS360	XS400D	XS400E, F2F	XS400-2E	XS400C/SG,H
Type	Mikuni BS34	Mikuni BS34	Mikuni BS34	Mikuni BS34	Mikuni BS34
Main jet	135	142.5	132.5	137.5	135
Air jet	0.6	45	45	45	45
Jet Needle	4FP21-3	5Z1-4	5Z1-3	5Z1-3	5GZ9
Needle clip position (from top)	3	4	3	3	na
Needle jet	X-6	X-4	X-6	X-6	Y-2
Throttle slide	145	135	135	135	na
Pilot jet	17.5	42.5	42.5	42.5	42.5
Pilot screw (turns out)	1½	1¼	1¼	Preset	Preset
Float level (mm/in.)	26.6/1.05	32.0/1.26	32.0/1.26	25.7/1.0	27.3/1.1

## Assembly

Assembly is basically the reverse of the disassembly procedure. Note the following points:

1. Always use new gaskets and O-rings.

2. Exercise care when installing jets—they are made of soft brass and are easily damaged if overtightened.

# ELECTRICAL SYSTEM

## CHARGING SYSTEM

### Alternator

#### OUTPUT CHECK

**NOTE:** To give accurate results, the battery must be in good condition and fully charged before performing the output test.

1. Connect a D.C. voltmeter across the battery terminals.

2. Start the engine and let it run at about 2,000 or more rpm.

3. Battery voltage on the meter should be 14.5 v with a maximum allowable variation of 0.3 v.

4. If the voltage is greater than this, check the voltage regulator (see below). If it is less, check the alternator wiring, the regulator, and the rectifier.

**CAUTION:** Never run the engine with the battery leads disconnected. To do so risks ruining the other charging system components.

#### FIELD COIL/ARMATURE TESTS

1. With the engine off, disconnect the alternator wiring at the connector. With an ohmmeter, check the resistance between each of the three white leads. Resistance should be 0.72 ohms.

2. If the resistance is not within 10% of this value, the problem is probably with the alternator armature wiring. If the resistance is too high, the wiring is probably broken; if it is too low, the windings may be breaking down. In either event, the armature must be replaced.

3. Check the resistance across the two

field coil leads (green-green). Resistance should be 4.0 ohms. If the measured resistance is not within 15% of this figure, replace the field coil.

**NOTE:** Resistance figures are taken at 20° C (68° F). Therefore, it is preferable to

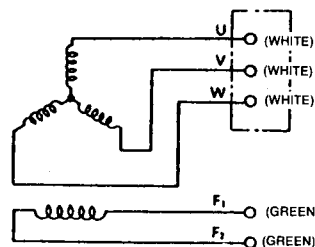

Alternator wiring schematic

# Yamaha XS360-400

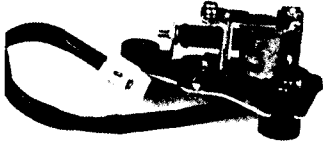

Voltage regulator

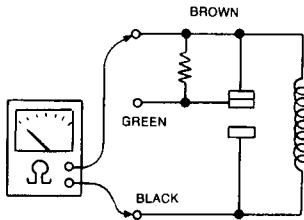

Checking resistance between the brown lead and ground

*check them when the engine is cold to ensure accuracy.*

## Regulator

A mechanical voltage regulator is used on all models. The regulator is adjustable, although this procedure (given below) should not be attempted until the regulator has first been checked for defects.

1. Perform the alternator output test and field coil/armature tests first. If the alternator proves satisfactory, check the regulator.
2. Disconnect the wiring and remove the regulator from the motorcycle.
3. With an ohmmeter, check the resistance between the black regulator lead and the regulator base (black). Resistance should be 10.5 ohms. If the measured resistance is not within 2 ohms of this figure, replace the regulator.
4. Check the resistance between the green and the brown regulator leads. Resistance should be 140 ohms. If the measured resistance is not within 10 ohms of this figure, replace the regulator.
5. If the resistance tests indicate that the regulator winding and resistor are satisfactory, but the charging system is not developing the standard 14.5 v across the battery, the regulator may be in need of adjustment. However, it would be wise to check the rectifier first.
6. Remove the regulator cover. Install the unit on the motorcycle, checking that all wiring connections are correct.
7. Disconnect the fuse box wire leading to the battery. Connect a voltmeter from the fuse box to ground. Start the engine and allow it to run at 2,500 rpm. At this point, the voltmeter should read 14.5–15.0 v. If it does not, turn the regulator adjusting screw to obtain the correct voltage output. Turn the screw *in* to raise the voltage output, and *out* to lower it.

## Rectifier

1. The rectifier consists of a six-diode "bridge." A diode will allow current to pass in one direction only. If any diode allows current to pass in both directions, or in neither direction, the operation of the entire unit will be upset and the rectifier will have to be replaced.

2. It is the ability of the diodes to pass current one way and stop it in the other which is tested when checking the rectifier.

3. The rectifier can be checked with an ohmmeter or a self-powered low-voltage test light. Disconnect the rectifier wiring and remove it from the motorcycle.

4. Connect the positive lead of the tester to the rectifier red lead and the negative tester lead to each of the three white leads in turn. Note whether or not there is continuity in each case. Now reverse the tester connections so that the negative tester lead is connected to the red rectifier lead and the positive tester lead is connected to each white lead in turn. Note whether or not there is continuity.

If there was continuity for a certain connection during the first test, there should not be any when the tester leads are reversed. If there was continuity in both cases, or lack of continuity in both cases, a diode is defective and the rectifier must be replaced.

5. Connect the positive lead of the tester to the rectifier black lead and the negative tester lead to each of the three white leads in turn. Repeat the test with these connections. Replace the rectifier if all tests are not satisfactory.

## BREAKER POINT IGNITION

### Troubleshooting

1. In the event of failure of the ignition system, first check the fuses; if all are in working order, check that the snap connectors for the coils and breaker points are all clean and tight.
2. At this point refer to chapters 2 and 3 for inspection procedures for the breaker points, plugs, and battery. If these items are all in working order, the problem may be isolated to the coils, condensers, or plug caps.
3. If only one cylinder fails to fire, and the problem is not a loose connection or defective spark plug, suspect the plug cap. The caps are fitted with a resistor to prevent radio interference while in operation, and heat and vibration may cause the value of this resistor to increase considerably, even to becoming an open circuit.

The easiest way to see if a misfire is due to a defective cap is to switch the plug cap of the non-firing cylinder with the other cap. If the dead cylinder begins to fire and the other cylinder ceases, the problem is the plug cap. The caps should be replaced as a set.

Functional caps will have a resistance of 9,000 ohms. Usually, when resistance exceeds this value significantly, the plug for that cap will no longer fire.

Caps are easily removable by unscrewing them from their cables.

4. Defective condensers are seldom a problem, since these are now usually replaced along with the breaker points. Defective condensers will cause considerable arcing or sparking between the breaker point contacts while the machine is running, and this should be cause for replacement before they fail completely. Badly burned or pitted point contact surfaces can also be caused by defective condensers, as well as by improper adjustment. If the points are in bad condition, replace them and the condensers as well.

5. Condenser capacity can be checked with electrical test equipment (if available) in place on the machine, provided the condenser is first disconnected from the primary terminal. Capacitance should be 0.24 MFD. The resistance of the condensers should be in excess of 3 M $\Omega$ . A variation of 10% in either reading is allowable.

6. If the condensers are not suspect, check the ignition coils. Coils should be checked for continuity of the windings. First remove the gas tank. Disconnect the red/white coil lead and the other lead which is orange for the left cylinder's coil, or grey for the right. Check resistance across the leads. It should be about 4 ohms. If the resistance is not very close to this figure, the primary winding is defective and the coil must be replaced.

7. To check the secondary coil, first remove the spark plug cap from the plug lead. Check the resistance between the plug lead and the orange or grey lead. Secondary winding resistance should be 9.5 K ohms. If the measured resistance is not very close to this value, the secondary winding is breaking down, and the coil must be replaced.

## TRANSISTORIZED IGNITION

### Troubleshooting

1. In the event of spark failure, first check the entire electrical system for loose connections.
  2. Check that the battery is fully charged. Recharge if necessary.
  3. Check all fuses.
  4. If all of the above elements are found satisfactory, check the resistance of the ignition coil primary and secondary windings. Primary winding resistance should be about 3 ohms. Secondary resistance should be about 8.6 K ohms.
- The primary winding leads at the coils are red/white and orange. The secondary winding resistance is checked between the spark plug lead (minus cap) and the re/white lead.
5. Check the pick-up coils' resistance. It should be about 700 plus/minus 150 ohms.
  6. If all of the above elements are satisfactory, replace the TCI unit.

### Pick-up Coil

#### REMOVAL AND INSTALLATION

The pick-up coils are located beneath the cover on the left side of the cylinder head.

1. Centerpunch the blind plug which secures the cover. Use a 5 mm drill bit to drill the plug.
2. Cut internal threads 6 mm diameter x 1.0 mm pitch in the blind plug with a proper sized tap. Thread in the special slide hammer, or a suitable metric bolt, and pull out the plug.
3. Remove the cover screws and take off the cover.
4. Remove the rotor bolt and rotor.
5. Remove the pick-up coil screws and take off the assembly.
6. Installation is the reverse of removal. Install the rotor and tighten the rotor bolt to 7 ft lbs. Check the ignition timing as outlined in "Tune-Up." Rotate the pick-up coil base plate, if necessary, until the timing marks align as specified. After fitting the pick-up coil cover, install a new blind plug. Do not



force the plug in if it is too tight, as this may crack the cover.

## STARTING SYSTEM

The starting system consists of the starter motor and clutch, the solenoid, and the handlebar-mounted starter switch. When the button is pressed, the electrical circuit to the solenoid is closed and the solenoid is activated, sending the battery current directly to the starter motor. The starting system is quite reliable and it is unlikely that any major problems will arise.

### Testing

If the starter will not operate, switch on the headlight and observe its intensity. If it is dim when the starter is not being operated, check the battery connections and recharge the battery. If the headlight doesn't light, check the fuse, the battery connections, the ignition switch and its connections, and check the continuity of the wire between the ignition switch and the battery.

If the headlight is normally bright, press the starter button and observe any changes. If the headlight dims when the button is pushed, it indicates that the starter motor is drawing current. If it does not dim (i.e. nothing happens), the starter motor is probably not getting any current. In this case, suspect the starter solenoid.

To check the solenoid and starter button, the easiest test is to bypass the unit completely by disconnecting the battery lead from the solenoid and connecting it directly (with the aid of a high-tension jumper cable) to the starter motor terminal. If the starter motor works, the solenoid or starter button is defective and must be replaced.

If the motor still fails to work, the motor itself may be the cause of the trouble.

Starter motor faults are rare, but several things can go wrong.

If the starter spins freely, but the engine doesn't turn over, suspect the starter motor clutch.

If the engine will turn over only very slowly and without a great degree of predictability, some possible causes include: a low or almost dead battery, oil which is too thick for weather conditions (extreme cold), or bad bearings in the motor itself. Worn bearings could cause the armature to contact the field coils which will effectively short out the starter. Usually, repeated attempts at starting will result in the starter motor getting very hot. Other possible causes of starter motor trouble include worn brushes, a worn or dirty commutator, or a defective armature.

## Starter Motor Service

### REMOVAL AND INSTALLATION

1. Remove the gas tank. Remove the carburetors.
2. Remove the starter motor cover. Disconnect the starter lead.
3. Remove the alternator cover.
4. Remove the starter motor bolts.
5. Remove the gear from the starter motor shaft and take out the starter motor.
6. Installation is the reverse of removal.

## INSPECTION

1. Take out the two screws and remove the starter side cover.
2. Check electrical continuity between the commutator and armature core using a multimeter or test light and battery. If continuity exists, the armature coil is grounded and the complete starter motor unit must be replaced.
3. Check for continuity between all of the commutator segments. Continuity must exist in each case.
4. Check continuity between the brush that is wired to the stator coil and the starter motor cable. Lack of continuity indicates an open circuit in the stator coil, and the starter motor unit should be replaced. Resistance should not exceed 0.05 ohms.
5. Examine the carbon brushes for dam-

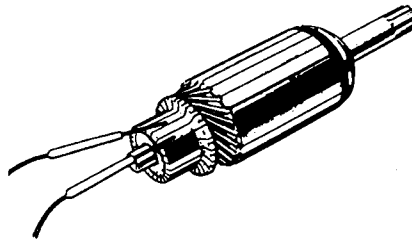

Checking for continuity between commutator segments

age to the contact surfaces and measure their length. Replace the brushes as a set if either one measures less than 6 mm (0.24 in.), or if they are damaged in any way.

6. Brush spring tension should be measured with a small pull-scale. Replace the springs if they have weakened to less than 550 g tension.

7. The mica undercut of the commutator should be maintained at 0.7 mm (0.027 in.). Any carbon deposits should be cleaned out of the commutator grooves, and a piece of hacksaw blade or the like used to increase the undercut depth if necessary.

8. Polish the commutator with fine emery cloth and then clean it thoroughly before installing.

9. Measure the diameter of the commutator. The armature should be replaced if the measurement is less than 27 mm (1.06 in.).

10. Check the condition of the armature bearings and replace them as a set if any damage is noted.

11. Check the condition of the oil seal and replace it if the seal lips are cracked or worn.

12. Unsealed bearings should be lubricated with 20W or 30W motor oil before assembly. Coat the lips of the oil seal with white grease before assembly.

## Starter Solenoid

1. If the battery is in reasonably good condition, and nothing at all happens when the starter button is pushed, check the solenoid.
2. Disconnect the starter cable at the solenoid. When the button is pushed, there should be an audible "click" which indicates that the solenoid is opening.
3. If further testing is necessary, remove the solenoid from the machine.

**CAUTION:** Be sure to disconnect the cables at the battery before disconnecting the solenoid terminals.

Connect a fully charged 12-volt battery across the solenoid low-tension leads and check for continuity across the high-tension terminals with an ohmmeter or self-contained test light. If there is no continuity, replace or repair the solenoid.

4. Check for continuity across the low-tension terminals with an ohmmeter or self-powered test light. Resistance should be 3.5 ohms. If there is no continuity, the primary winding of the solenoid is broken, and the unit must be replaced.

5. If starter trouble began just after the starter button housing was disassembled or moved for any reason, check the connections at the switch as they may have come adrift.

## ELECTRICAL COMPONENTS

### Horn

1. If the horn fails to sound, check that there is 12 v on the brown horn lead. If there isn't, check for a broken wire.

2. If the brown lead checks out, check that the pink wire is grounded when the horn button is pressed. If it isn't, check the horn button.

3. If the wiring is satisfactory, replace the horn.

### Brake Light

1. If only one of the two brakes fails to activate the brake light, the problem is probably confined to that switch.

2. If neither switch will activate the brake light, first check the brake light bulb. If it is in workable condition, check that there is 12 v on the yellow brake light lead.

3. If there is voltage on the yellow lead, check for voltage on each brown lead at the brake light switches.

### Taillight

1. If the taillight will not work, check the bulb first.

2. If it is satisfactory, check for voltage on the blue lead. If there is voltage on this wire, check for a good ground (black wire).

### Turn Signals

1. If only one side fails to work, check both bulbs on that side first.

2. If the bulbs are operable, check for voltage on the green (right) or brown (left) leads. If there is voltage here, check the grounds (black leads).

3. If neither side will work, check for voltage on the brown/white lead at the handlebar turn signal switch. Then check for voltage on the brown lead at the turn signal flasher relay.

4. If these checks are satisfactory, replace the flasher relay. If the turn signals still will not operate, replace the flasher switch. If this will not work, the entire self-cancelling system must be checked out (see below).

### Neutral Indicator

1. If indicator light fails to come on, check the bulb first.

2. If the bulb is satisfactory, check that there is voltage on the blue wire at the switch. If there is, replace the switch itself.

# Yamaha XS360-400

## Oil Pressure Indicator

1. Check the bulb first.
2. If the bulb is satisfactory, check for voltage on the black/red lead to the switch.
3. If the wiring checks out, replace the oil pressure indicator switch.

## Self-Cancelling Turn Signal System

1. In the event that the self-cancelling system fails to operate properly, first disconnect the 6-prong connector from the flasher cancelling unit and try the turn signals. If both sides operate normally, the trouble can be confined to the cancelling unit itself, the handlebar switch reset circuit, or the speedometer sensor circuit.

2. Connect an ohmmeter set to the R x 100 range across the white/green and black wires on the wiring harness side of the 6-prong connector. Turn the speedometer shaft. The ohmmeter needle should swing back and forth between zero and infinity four times. If this happens, it indicates that the speedometer sensor circuit is functioning properly. If the meter does not function in this manner, either the sensor or the wiring harness is defective.

3. Check for continuity between the yellow/red lead of the 6-prong connector on the wiring harness side and ground on the chassis. When the turn signal switch is *off*, there should be infinite resistance. When the switch is pushed to either "L" or "R", there should be no resistance. If this is not the case, check the wiring harness and the handlebar switch circuit.

4. If no defective operation is apparent in the above tests, replace the self-cancelling unit.

5. If the turn signals operate only when

the turn signal button is pushed to "L" or "R" and they shut off immediately when the button is released, replace the self-cancelling unit.

Note the following concerning the self-cancelling turn signal system:

a. Yamaha recommends that the turn signals be shut off manually after a turn is completed.

b. If the self-cancelling unit fails, the turn signals can be used manually by simply disconnecting the 6-prong connector from the unit.

## Bulbs

Headlight	40/30W
Tail/Brake light	8/27W
Turn signals	27W
Meter lights	3.4W
Warning lights	3.4W
Indicator lights	3.4W

## Fuses

Main (red)	20A
Headlight (red/yellow)	10A
Turn signal (brown)	10A
Ignition (red/white)	10A

## WIRING DIAGRAMS

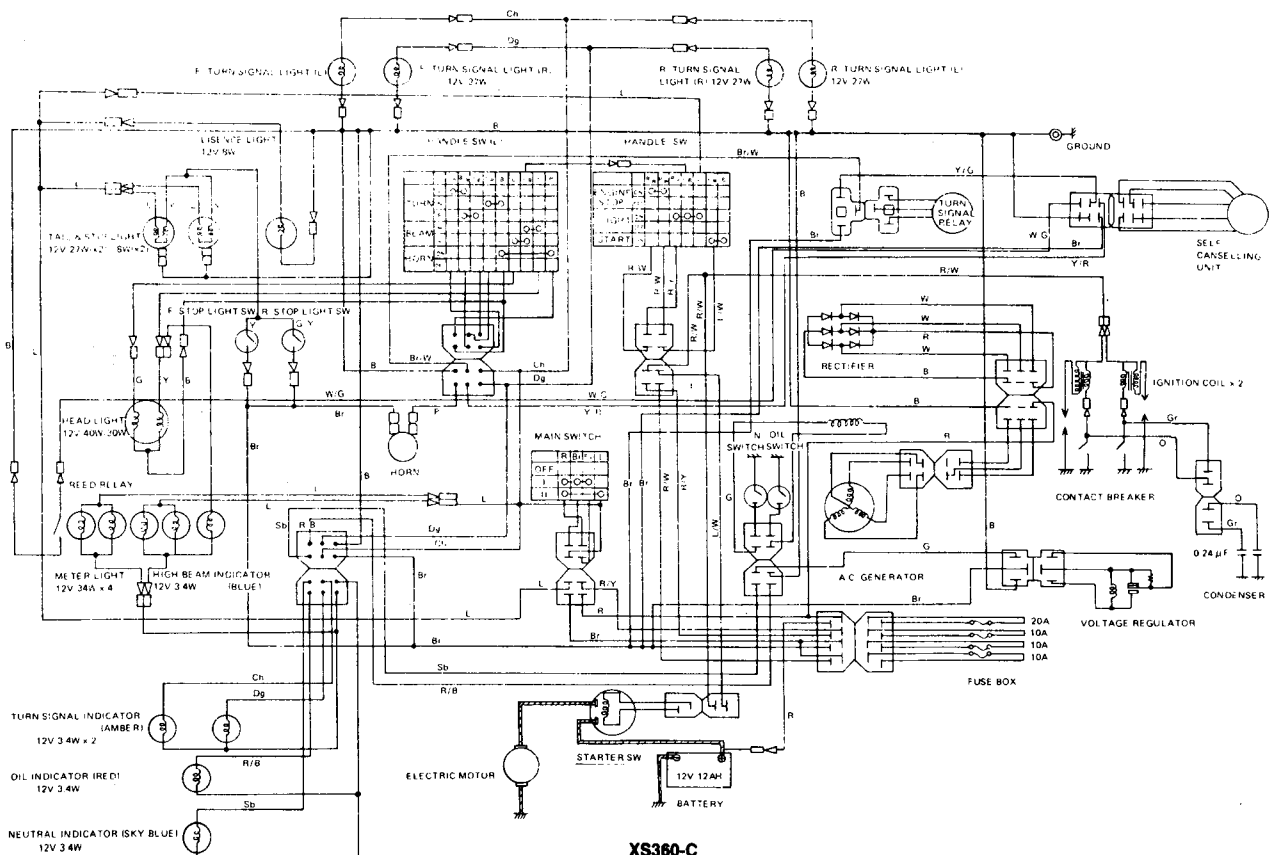

XS360-C

## WIRING DIAGRAMS

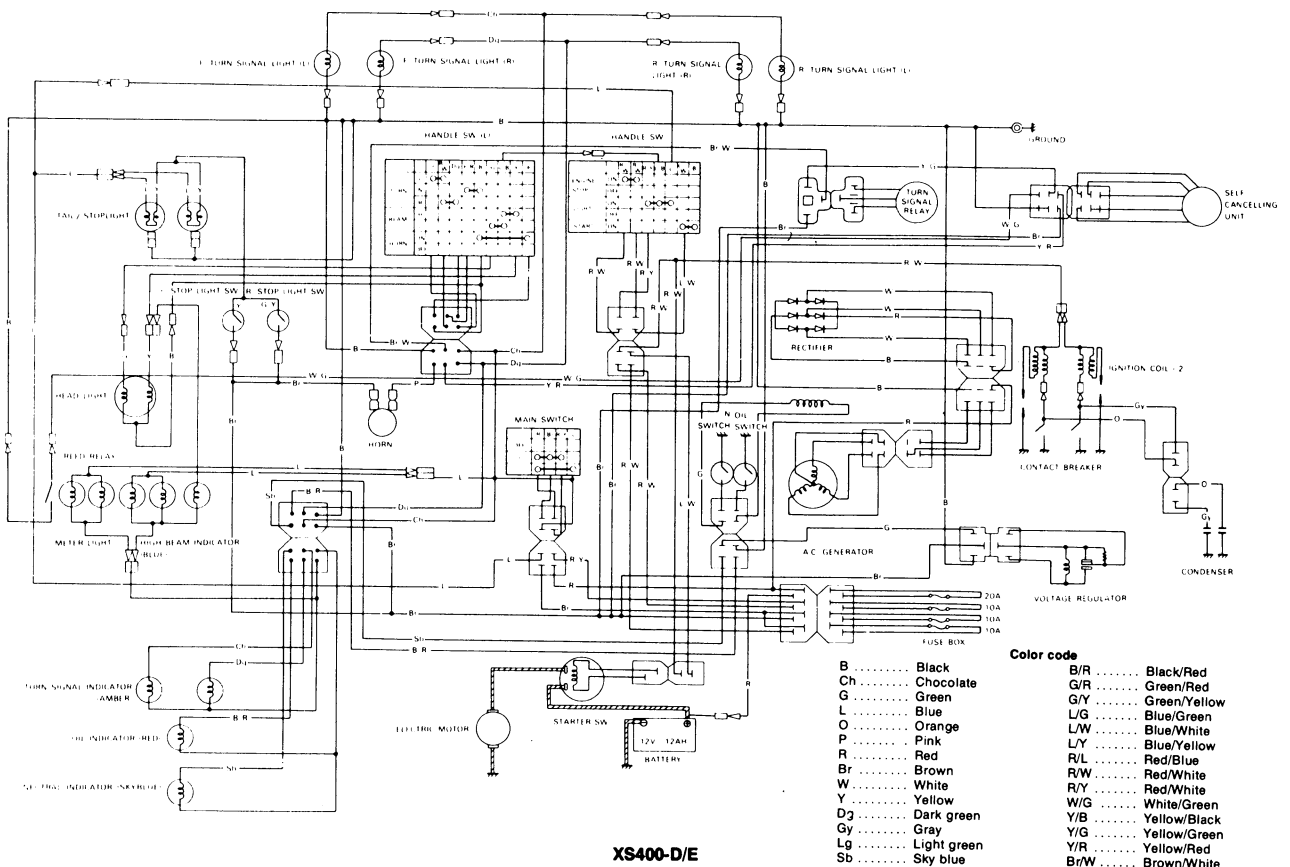
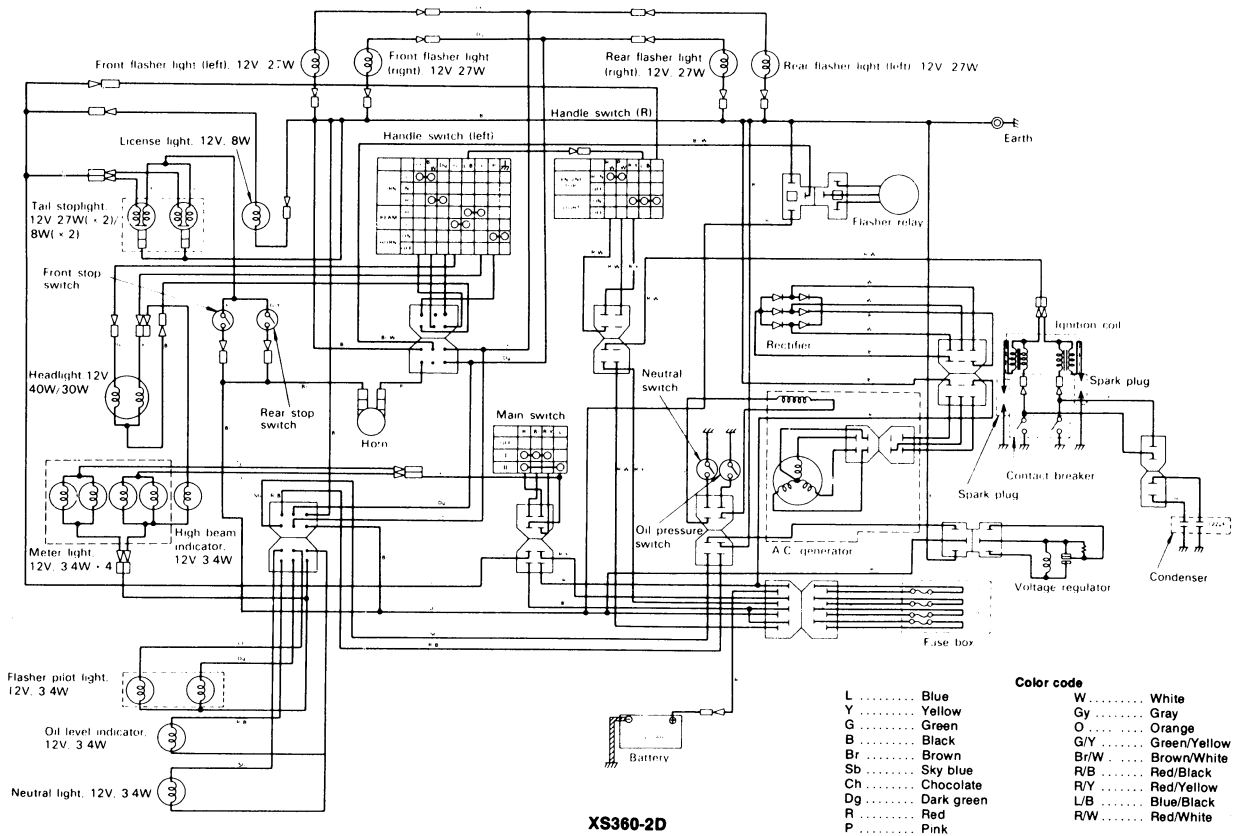

## WIRING DIAGRAMS

\* The key can be removed in this position

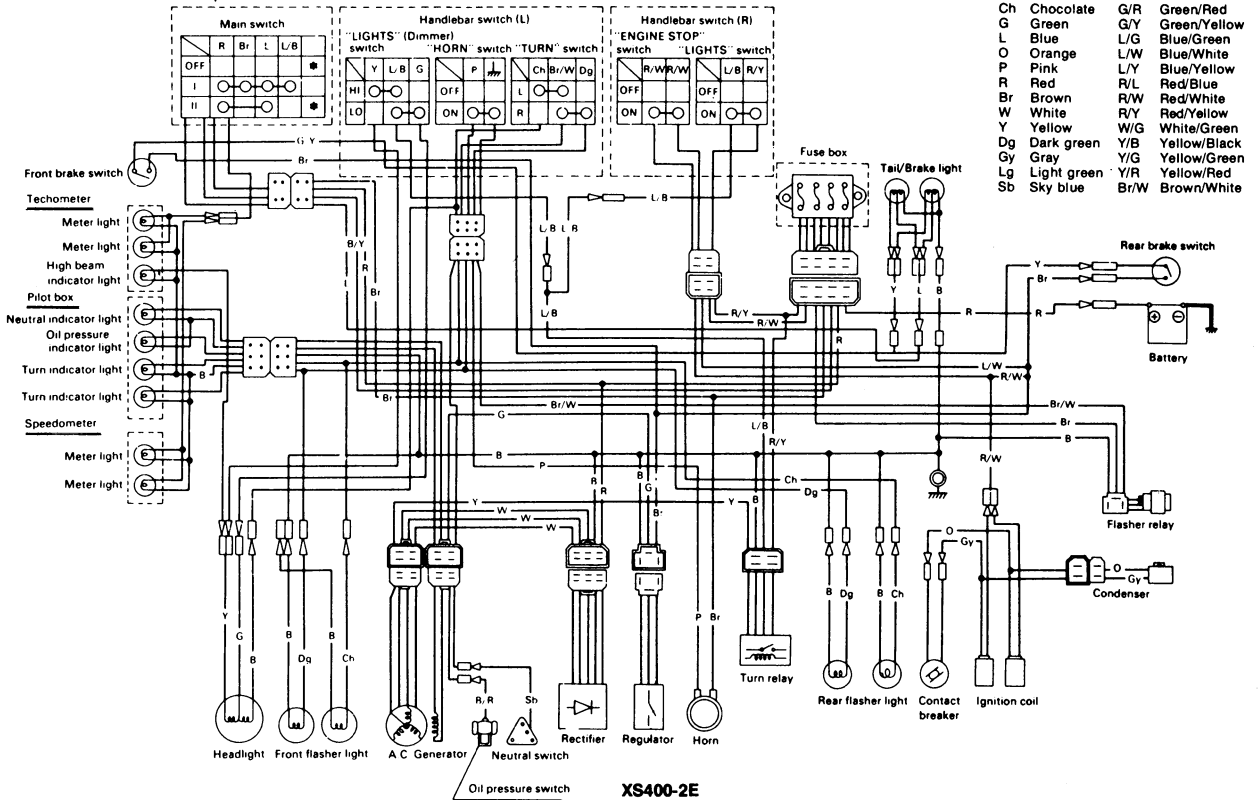

--- XS400F only

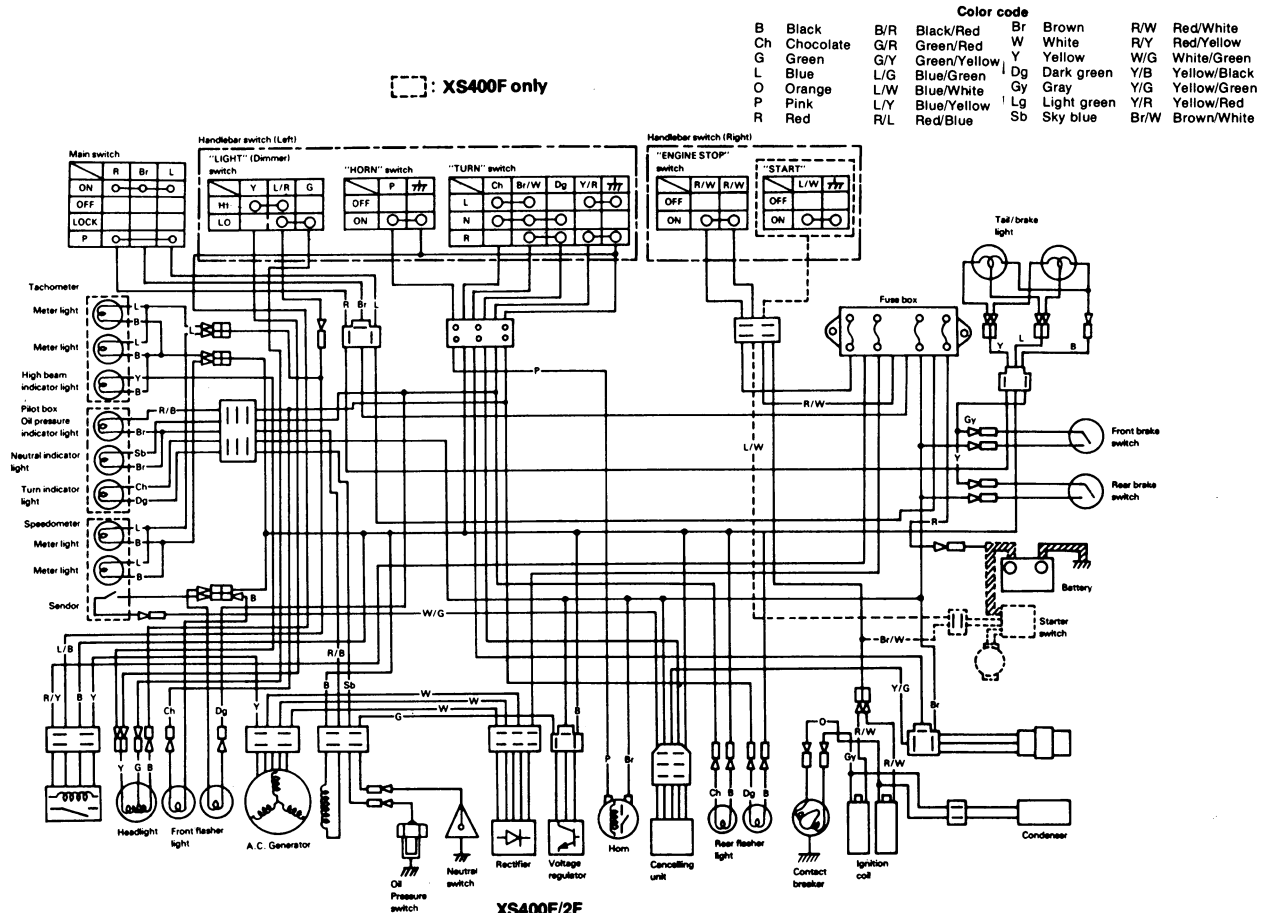

## WIRING DIAGRAMS

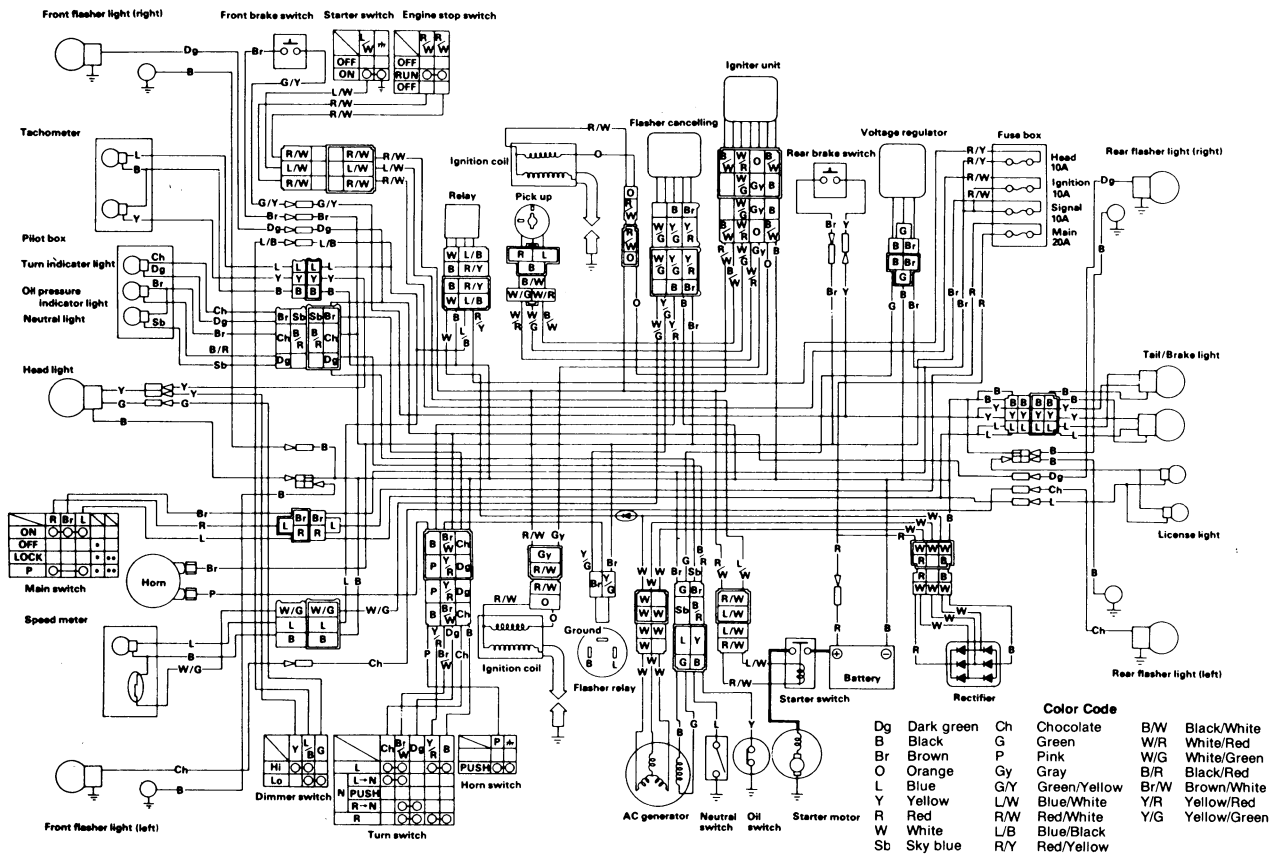

XS400G/SG, 1981 models

## CHASSIS

### WHEELS

#### Front Wheel Assembly REMOVAL AND INSTALLATION

- Support the front wheel several inches off the ground by placing a support beneath the engine.
- On drum brake models, disconnect the brake cable at the handlebar.
- Disconnect the speedometer cable at the wheel.
- Remove the axle nut cotter pin and remove the axle nut.
- Loosen the axle cap nuts. Pull out the axle and remove the wheel from the machine.
- On disc brake models, place a piece of cardboard or the like between the brake pads to keep them apart.
- Installation is basically the reverse of removal. Note the following points:
  - Grease the lips of the wheel grease seals and the speedometer drive mechanism with white grease.
  - On drum brake models, be sure to engage the brake anchor with the slot on the fork slider. On disc brake models, be careful when fitting the wheel so that the brake disc is properly installed between the pads.

- If the axle cap has been removed, install it so that the arrow on it points towards the front of the motorcycle.
- When tightening the axle cap nuts, tighten the frontmost one first. Torque it to 15 ft lbs. Then tighten the rear one to the same torque. The cap is machined unevenly. There should be a small gap between the cap and the fork slider visible above the rearmost nut.
- Tighten the axle nut to 72 ft lbs on drum brake models and 77 ft lbs on disc brake machines. Use a new cotter pin.



Tighten the forwardmost axle cap nut first; there should be a gap between the cap and the slider at the rear (arrow)

- Check brake operation *before* riding the motorcycle.

### WHEEL BEARINGS

#### Removal

- After removing the front wheel, remove the brake plate on drum brake models, or the brake disc on disc brake machines.
- Remove the speedometer drive box on disc brake machines.
- Remove any wheel bearing covers or retainers fitted to either side of the hub.
- Pry out the grease seals. Once removed, the seals should be replaced with new ones.
- Reach through the hub with a suitable punch, move the wheel bearing spacer as far as possible to one side to achieve a purchase on the wheel bearing, and drive it out. Remove the spacer. Drive out the remaining wheel bearing from the other side of the hub.

#### Inspection

- Wash the wheel bearings thoroughly in a solvent to remove all of the old grease.
- Inspect the general condition of the bearings. There should be no rust, pitting, or obvious signs of wear or damage on either balls or races.
- Slowly rotate the bearings. Rotation

# Yamaha XS360-400

should be smooth, noiseless, and free of binding or unevenness. If any of the above conditions exist, both bearings should be replaced.

4. Place each bearing on a flat surface and hold the inner race firmly in place. Attempt to move the outer race up and down. If any play is evident, the bearings should be replaced.

5. If equipment is available, a dial gauge can be used to check bearing run-out. Pass the axle through each bearing in turn and check the axial and diametrical run-out with the gauge. If axial run-out exceeds 0.1 mm (0.004 in.) or if diametrical run-out is greater than 0.05 mm (0.002 in.), the bearings should be replaced.

To check diametrical run-out, the dial indicator is placed directly on top of the outer race and the race moved up and down.

To check axial run-out, the gauge is positioned to bear against the side of the outer race and the race moved back and forth while holding the inner race in place.

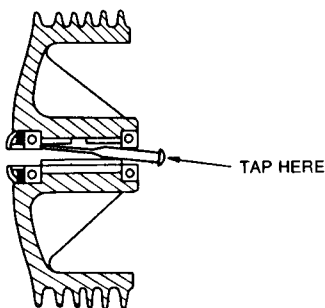

Removing a wheel bearing

## Installation

Assembly is the reverse of the above.

Note the following points:

a. Pack the bearings with a good grade of wheel bearing grease. Put a small handful of the grease in the hub as well.

b. Do not forget to install the spacer in the hub before installing the bearing.

c. Bearings may be driven into place using a suitably sized socket or a bearing driver. If one side of the bearing is sealed, install it with the sealed side facing outward.

d. Use new grease seals and lubricate them with oil to make installation easier.

## Rear Wheel Assembly

### REMOVAL AND INSTALLATION

#### Rear Drum Brake

1. Park the motorcycle on the center stand.

2. Remove the brake rod adjusting nut and disconnect the brake rod from the lever on the brake plate.

3. Disconnect the brake anchor from the brake plate.

4. Remove the cotter pin and loosen the axle nut. Loosen the chain adjuster bolt locknuts. Back off the adjuster bolts.

5. On models with a masterlink chain, disconnect the chain. On models with an endless chain, fold down the adjuster plates and push the wheel as far forward as possible. Disengage the chain from the sprocket.

6. Remove the axle nut and pull out the axle. Remove the wheel from the motor-

cycle, noting the locations of any spacers or collars.

7. Installation is the reverse of removal. After adjusting the chain tension, tighten the axle nut to 50–72 ft lbs. Use a new cotter pin.

#### Rear Disc Brake

1. A special tool is needed to remove the rear wheel. This tool, a length of wire with hooks to support the rear wheel, is supplied in the tool kit.

2. With the machine on the side stand, attach one end of the tool to the frame hook. Compress the shocks as much as possible and hook the other end of the tool to the swing arm. Place the machine on the center stand.

3. Disconnect the drive chain.

4. Remove the axle nut cotter pin and unscrew and remove the axle nut.

5. Hold the brake caliper in position so it will not fall out of place, and pull out the axle. Remove the rear wheel assembly.

**NOTE:** Do not apply the brake while the wheel is off the machine.

6. Installation is the reverse of removal. Before fitting the wheel, check that there is sufficient clearance between the brake pads to install the disc. Grease the lips of the wheel bearing grease seals. Tighten the axle nut to 77 ft lbs.

#### WHEEL BEARINGS

Removal, inspection, and installation of the wheel bearings is accomplished in basically the same manner as for the front wheel described above.

#### TUBELESS TIRES

##### Precautions

Some models are equipped with aluminum wheels which are compatible with either tube or tubeless tires. Tubeless tires are installed at the factory. Obey the following precautions when dealing with tubeless tires.

1. Do not attempt to use tubeless tires on wheels which are not specifically designed for them.

**WARNING:** Injury or tire failure may result from using tubeless tires with incompatible wheels.

2. Tire pressure is critical. Always maintain pressure at the proper specification.

3. Check tire condition before riding.

4. Aluminum wheels cannot be repaired. If the wheel is bent or cracked, it must be replaced.

5. After changing or fitting a new tire, ride with caution for several miles to allow the tire to seat itself properly on the wheel.

6. Be sure that the valve stem locknut is securely fastened.

7. Changing a tubeless tire is basically the same as described for tube types in the "General Information" section.

8. The tubeless wheels fitted to these motorcycles will accept a tube and tube type tire if so desired. Be sure, however, that the tube is the proper size for the tire and that the tire matches the rim.

9. Do not attempt to fit oversized (wider) tires to the standard wheels.

#### DISC BRAKE SERVICE

When handling disc brake fluid, observe the following precautions:

a. Use DOT #3 brake fluid only. Do not mix types or brands of brake fluid. Since the fluid in the motorcycle may be incompatible with the fluid you wish to add, it is wise to flush the entire system and refill it with the new fluid. The brake system should be flushed and refilled with fresh brake fluid about every two years in any case.

b. Never use brake fluid from an old or unsealed container. Brake fluid is hygroscopic: it absorbs moisture. Therefore, brake fluid left in a container which is not tightly sealed will quickly become useless.

c. When working on the disc brake system, be sure that all components are scrupulously clean. Clean the tops of brake fluid cans, the master cylinder reservoir, etc., before removing their caps. Be sure hands and tools are free of foreign matter and that rags are at least reasonably dirt-free.

d. Brake fluid will remove paint in short order. Be sure that all painted surfaces which can come in contact with the brake fluid through spillage or other accidents are well covered. This includes items such as the gas tank and frame.

#### FLUSHING

The brake system should be flushed out every 12,000 miles, or every 2 years.

1. Attach a length of vinyl tube to the bleed valve on the brake caliper and put the other end into a small container.

2. Remove the master cylinder cap, and the diaphragm. Loosen the bleed valve about ½ turn. Pull the brake lever slowly to the handgrip, then tighten the bleed valve. Release the lever. Repeat until the master cylinder is almost empty.

3. Add new brake fluid to the master cylinder and continue squeezing and releasing the brake lever slowly until the new fluid begins to come out of the vinyl tube. Bleed the system as outlined below.

#### BLEEDING

The brake hydraulic system must be bled whenever any part of the system has been disconnected or removed for service. When refilling the master cylinder reservoir, use

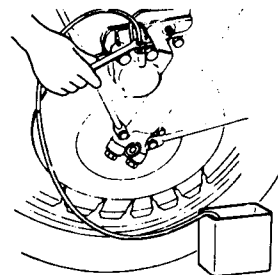

Bleeding the brake system

only brake fluid conforming to DOT 3 specifications. Any brand meeting this requirement is acceptable. The brake fluid container of all reputable brands will be plainly marked with the standards the fluid meets or exceeds.

**NOTE:** It is sometimes helpful to let the cycle sit for several hours before bleeding the system. Pulling and tapping on the lines will help expel any air bubbles trapped in the system. If you find that you can't get the system bled properly and the

master cylinder has been dry for awhile, the seals inside the cylinder may have become dried and cracked. In this case rebuild the master cylinder.

1. Top up the reservoir with brake fluid and replace the cap to keep dirt and moisture out and the fluid in. Cover the gas tank with a thick cloth to avoid damage due to spilled brake fluid.

2. Attach one end of a small diameter rubber hose to the bleed valve on the caliper, and place the other end in a jar which contains several inches of clean, new brake fluid. Be sure that the end of the hose is submerged in this fluid. Arrange the hose so that it loops upward after leaving the bleed valve, and see that it has no kinks or sharp bends.

3. Pump the brake lever rapidly several times until some resistance is felt and, holding the lever against the resistance, open the bleed valve about one-half turn. When the lever bottoms, close the valve (do not over-tighten) and then release the lever.

4. Repeat the operation until no more air is released out of the hose and the brake lever is firm in operation. Check the fluid level in the reservoir often to make sure that it doesn't go dry and draw more air into the system. Do not reuse fluid that has been pumped out of the system. Do not use fluid that has been stored for more than a few weeks after the seal on its container has been opened, as brake fluid will absorb moisture from the air and may corrode the master cylinder and caliper.

5. Refill the reservoir to the level mark when through (but do not overfill). Avoid overtightening the cap or fluid will weep around the cap edge.

## Front Disc Brake

### PAD REPLACEMENT

1. Unbolt the caliper from the fork slider.
2. Remove the pad screw which secures the fixed pad on the wheel side of the caliper. Remove the fixed pad.
3. Remove the piston pad.
4. Installation is the reverse of removal. Secure the fixed pad phillips screw with a non-permanent thread-locking compound.

## CALIPER

### Removal

1. Disconnect the brake line from the caliper. Plug the end of the brake line to prevent loss of brake fluid.
2. Remove the mounting bolts and take the caliper from the fork slider.

### Disassembly

1. Remove the phillips screw which secures the fixed pad and take out the pad and pad spring.
2. Remove the piston pad.
3. Remove the caliper support bolt. Separate the caliper and support bracket. Remove the piston dust seal and retaining ring.
4. Apply compressed air to the brake line fitting on the caliper and force out the piston.

Caution: Be sure your fingers are clear of the piston, as it may come out with some force.

5. Remove the piston seal.

## Inspection

1. Clean all parts in new brake fluid. Do not use gasoline or other solvents.
2. All rubber parts should be replaced with new ones once the caliper has been disassembled. These parts should also be replaced every two years as a matter of preventive maintenance.
3. Check the piston for scoring or other obvious signs of wear, and replace it if damage is noted. Check the caliper bore as well.

## Assembly

1. Using a new caliper support bolt is recommended. As noted above, all rubber parts must be replaced as well.
2. Lightly lubricate the piston seal with fresh brake fluid and install it in the caliper. Be sure that the seal is properly seated.
3. Lubricate the sides of the piston with brake fluid and install it.
4. Fit the caliper and support bracket together, not forgetting the bushing and bushing boot. Install the support bolt and tighten it to 11-15 ft lbs.
5. Install the brake pads. Secure the fixed



Caliper mounting bolts

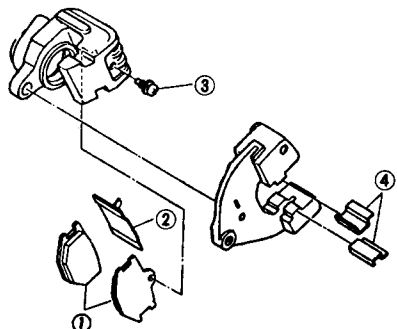

Caliper pad components: 1, pads; 2, pad spring; 3, screw; 4, retainers

pad phillips screw with a non-permanent thread-locking compound. Grease the pad-shim contact area before installation. Bend each tab of the shim over the piston pad.

## Installation

1. Tighten the caliper mounting bolts to 21-29 ft lbs.

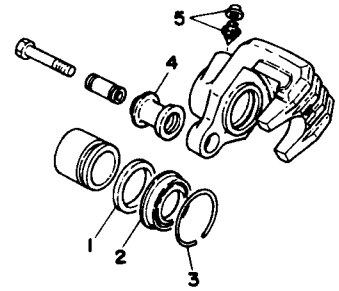

Caliper components: 1, piston seal; 2, boot; 3, dust cover clip; 4, bushing boot; 5, bleed screw

2. Tighten the brake line banjo bolt to 18-25 ft lbs. Bleed the system.

## MASTER CYLINDER

### Removal

1. Disconnect the front brake light switch leads.
2. Remove the brake lever. Note the return spring.
3. Disconnect the brake line from the master cylinder. Take adequate precautions to avoid spillage.
4. Remove the two master cylinder hand-lever clamp bolts and remove the master cylinder assembly.

### Disassembly

1. Remove the master cylinder cap and diaphragm and drain off and discard the brake fluid.
2. Remove the master cylinder rubber boot.
3. Remove the snap-ring. Take out the piston assembly. The spring will remain in the master cylinder.
4. Remove the spring and stopper valve.
5. Remove the stopper plate and the cylinder cups.

### Inspection

1. Clean all parts in fresh brake fluid.
2. Check the master cylinder port for clogging.

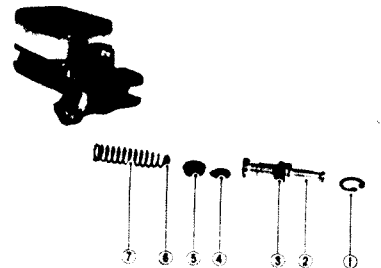

Master cylinder components

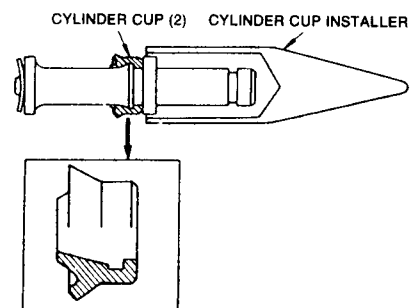

Installing the cylinder cup

# Yamaha XS360-400

3. Check the piston and cylinder bore for scoring and wear and replace the components if damage of this sort is noted.

4. Check the cylinder cups for cracking and dry-rotting and replace them if this condition is present.

## Assembly

1. Soak the cups in new brake fluid for a time before assembly.

2. Use the special cylinder cup installer when fitting the cup to the piston.

3. Install the stopper plate into the master cylinder. Insert the spring and valve.

4. Insert the piston into the master cylinder. Take care not to scratch the piston or cylinder wall. Fit the snap-ring. Be sure that it is firmly seated.

5. Fit the boot into the grooves of the master cylinder and piston.

## Installation

Bolt the master cylinder to the handlebar. Connect the brake and tighten the banjo bolt to 17–20 ft lbs. Fill the master cylinder with fresh brake fluid and bleed the system.

## DISC SERVICE

The brake disc normally requires no service of any kind. However, if the disc becomes scored for any reason, it should be replaced and a new set of pads should be installed. A badly scored disc will reduce the effectiveness of the brake and shorten pad life considerably. If the front brake lever oscillates or fluctuates when the brake is applied at speed, the indication is that the brake disc is warped or bent. Check the run-out of the disc with a dial indicator and replace it if run-out exceeds 0.15 mm (0.006 in.). Measure disc thickness. If it is less than 4.5 mm (0.18 in.), it should be replaced. To replace the disc:

1. Remove the wheel.
2. Bend back the locktabs, unscrew the bolts, and remove the disc from the hub.
3. Mount the new disc on the hub and tighten the bolts evenly, using new locktabs or thread-locking compound to secure them. Proper torque is 12–16 ft lbs.
4. Examine the brake pads and replace them if they are close to the limit of wear or have worn in an unusual pattern.

## Rear Disc Brake

The rear disc brake components are virtually identical to those for the front system except for the method of mounting.

To remove the rear caliper, disconnect the brake line from the caliper, unbolt the brake anchor, and remove the rear axle.

For all service procedures, refer to the "Front Disc Brake" section above.

## Front Drum Brake

1. Remove the front wheel from the machine. Take out the brake plate.

2. Check the linings for scoring, a glazed surface, or other unusual wear. Scored linings should be replaced. If the linings are only glazed, they can be roughed up with sandpaper. Be sure to clean them thoroughly after this operation.

3. Measure lining thickness at the middle and ends of each brake shoe. Minimum ac-

ceptable lining thickness is 2 mm (0.08 in.). New linings will have a thickness of 4 mm (0.16 in.).

4. Remove the shoes from the brake plate by folding them in towards the center.

5. Check the condition of the brake return springs. Standard free length of the springs is 68 mm (2.68 in.), and they should be replaced if they are stretched over this standard. Also check the springs for rust, damaged ends, or other obvious signs of age.

6. Measure the diameter of the brake drum in at least two directions. Standard diameter is 180 mm (7.1 in.). If the measured diameter exceeds this standard by more than a small amount, the drum should be replaced.

7. Rough up the surface of the brake drum

LINING THICKNESS

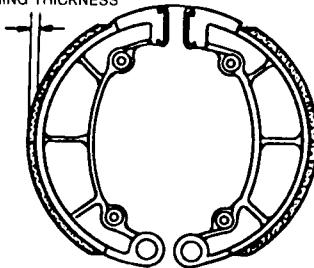

with sandpaper. Clean the drum out thoroughly before assembly.

8. Check for excessive play in the brake rod linkage. If play exists, the most obvious cause is wear wear of the clevis pins. Replace the pins as necessary.

9. The brake cams can be removed from the brake plate after removing the shoes and brake linkage. Mark the brake levers and cams before disassembly so the levers can be reinstalled in their original positions. Clean the cams in solvent. Remove any rust or corrosion with medium grade emery cloth. Check that the cams can rotate freely in their holes. Check the condition of the splines. Replace any bent or otherwise damaged cams. Before installation, smear the cams with a good grade of chassis grease.

## Rear Drum Brake

Service procedures for the rear drum single-leading shoe brake are similar to those for the front drum brake described above. The only difference is the brake drum diameter which is 160 mm (6.3 in.) for the rear brake.

## FRONT FORKS

### Removal

1. Remove the front wheel and fender.
2. On disc brake models, unbolt the caliper from the fork slider. Disconnect the brake line from the fork leg.
3. Loosen the upper and lower triple clamp pinch bolts. Pull each fork leg down and free of the triple clamps.

### Dissassembly

1. Remove the rubber fork caps, press down on the metal caps and remove the snap-

ring. Take out the cap and fork spring. Drain off the fork oil.

2. Remove the allen bolt from the bottom of the fork slider.

3. Separate the fork slider from the fork tube.

4. Remove the clip from the bottom of the fork tube and remove the piston assembly.

5. To remove the slider oil seal, remove the dust cover and the snap-ring and pry the old seal out. New seals must always be used on assembly.

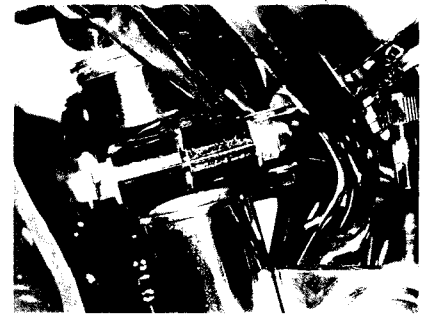

Upper triple clamp pinch bolts

### Inspection

1. Inspect the fork tubes for bends such as might have been incurred in an accident. Replacement is recommended rather than attempting to straighten bend fork tubes.

2. The chrome plating on the fork tubes must be in perfect condition in the area along which the slider oil seal rides. If the plating is chipped or flaking, the seal will leak. Dam-

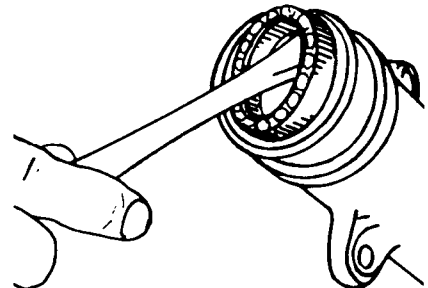

Removing a fork slider oil seal

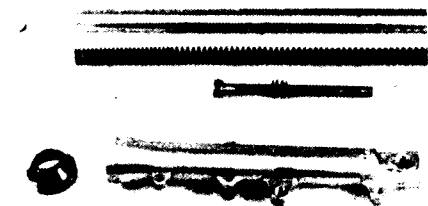

Fork components

age to the plating requires replacement of the fork tube.

3. Compare the spring heights of the fork springs from each fork leg. They should be equal. Standard spring free length is 484 mm (19.1 in.). If the spring heights are unequal, or if either or both of them has been compressed through use, both should be replaced.



4. Clean the damper components thoroughly in a safe solvent. Be sure that all bleed holes are clear. Clean out the inside of the fork sliders with solvent as well.

## Assembly

Assembly is the reverse of disassembly. Note the following points:

a. New slider oil seals must always be used. Drive the new seals straight into the slider (sealed side up) until there is sufficient room to install the snap-ring in its groove. Use a large socket or the like to install the seal. Be sure it is not cocked or twisted during the installation procedure. Install the snap-ring. Oil the lips of the seal before assembling the fork components.

b. Tighten the fork slider allen bolt securely. The threads of the allen bolt should be coated with a non-permanent thread-locking compound before installation.

c. The fork springs are progressively wound. They are installed so that the close coils are towards the top.

## Installation

1. Fit each fork leg up through the triple clamps until the top edge of the fork tube is flush with the upper surface of the upper triple clamp.

2. Tighten the lower triple clamp pinch bolts to 22-29 ft lbs.

3. Tighten the upper triple clamp pinch bolts to 7-10 ft lbs.

4. Fill each fork leg with 130 cc (4.4 oz) of the proper fork oil. Refer to the "Maintenance" section for oil recommendations.

5. Install the front wheel and fender and caliper assembly, if applicable.

## STEERING STEM ASSEMBLY

### Bearing Adjustment

1. The steering stem bearings are uncaged  $\frac{1}{4}$ -in. balls. They are adjusted by means of a ring nut beneath the upper triple clamp.

2. To check bearing adjustment, support the front wheel off the ground. Grasp the tip of the front fender and place your other hand beneath the lower triple clamp at the frame lug.

3. Attempt to move the fork by pulling up on the tip of the fender. If play or movement can be felt at the lower triple clamp, the bearings are adjusted too loosely or are worn. An alternate method is to grasp the fork sliders and attempt to move them back and forth in line with the motorcycle. No play should be noted.

4. Turn the forks slowly from lock-to-lock. Movement should be smooth, silent, and effortless. If any binding or uneven movement is felt, the balls and races are either too tightly adjusted or they are worn. If the steering feels uniformly stiff, the bearings are too tightly adjusted. If any noise is noted, the bearings are damaged or some are missing.

5. With the front wheel off the ground, release the front forks from a few degrees off the centered position. The fork should fall freely to either side of their own weight. If they will not, the bearings are too tightly adjusted, the steering stem is bent, the races are extremely worn, or some of the bearings are missing.

6. To adjust the bearings, remove the gas tank. The bearings are adjusted by means of the adjuster nut under the upper triple clamp.

7. Tighten or loosen the adjuster nut a little at a time until the steering stem adjustment conforms to that outlined above.

8. If proper adjustment is not possible, the bearings and races will probably need to be replaced.

## Disassembly

1. Remove the front wheel, front fender, and the fork legs.

2. Remove the headlight bracket.

3. Remove the gas tank. Disconnect the headlight wires beneath the tank.

4. Disconnect the wires between the handlebar switches and the main wiring harness.

5. Disconnect the clutch and throttle cables at the handlebars and the instrument cables at the instruments. On disc brake models, unbolt the master cylinder from the handlebar.

6. Loosen the steering stem pinch bolt. Remove the upper triple clamp fitting bolt and crown washer.

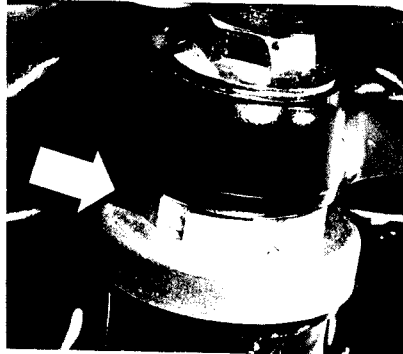

Steering head bearing adjuster nut

7. Remove the upper triple clamp complete with instruments.

8. Hold the lower triple clamp in place to prevent the lower race balls from falling out, and unscrew and remove the bearing adjuster nut. Remove the bearing cover.

9. Carefully lower the lower triple clamp/steering stem assembly out of the frame lug. Note that the lower race balls may fall out as the assembly is lowered.

10. Remove the top bearing cover and race and remove the ball bearings.

11. Remove the bottom cone race, dust seal, and dust seal washer from the steering stem if they are to be replaced. These will have to be pried off with a chisel; therefore only remove them if necessary.

12. The bearing races in the frame lug are a press-fit and should not be removed unless replacement is necessary. If replacement is necessary, the old races can be removed by reaching through the frame lug with a suitable punch and tapping the race evenly around its circumference to remove it from the inside of the frame lug. Be sure that the race does not become cocked in its seat upon removal.

New races are installed with a suitably sized bearing driver, i.e., one which will drive the race squarely into its seat. Be certain that the race goes straight in.

These races can also be installed using a block of hard wood of sufficient size to cover the race in place of a bearing driver.

## Inspection

1. Wash the ball bearings in a suitable solvent.

2. Clean all of the old grease from the bearing race surfaces, steering stem, and frame lug.

3. Inspect the bearing race surfaces. They must be clean and smooth and free of any cracks, scoring, rust, or indentations. Run your finger around each of the bearing races.

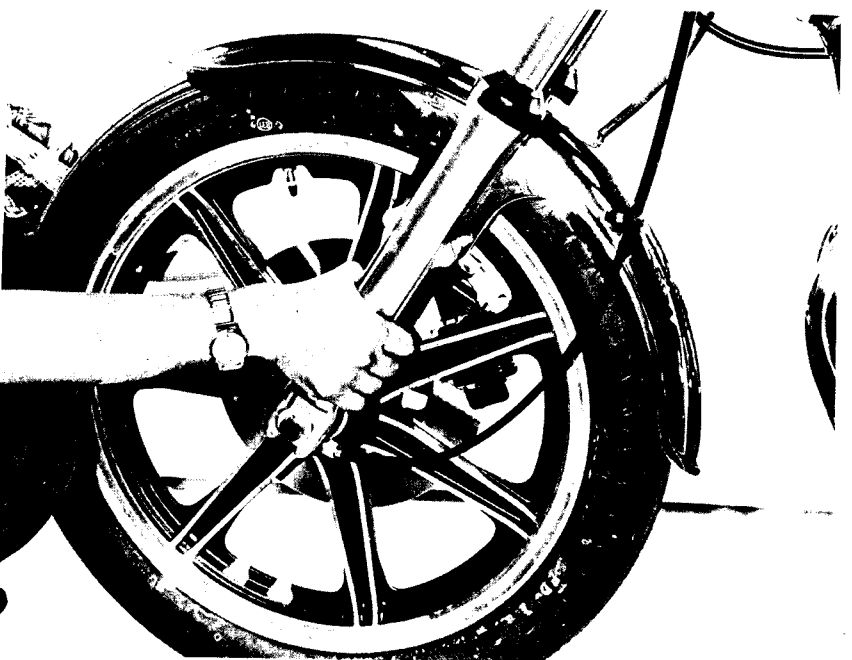

Checking steering head bearing play

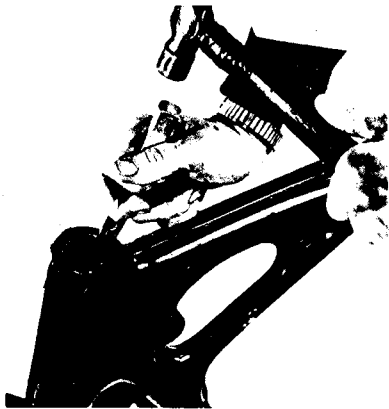

Removing the frame races

Note any roughness or ripples on the race surface. If any imperfections are noted, both sets of races and all of the balls must be replaced.

4. Check the balls themselves for rust, pitting, scoring, or flat spots. If the balls are found to be defective in any way, the balls and both sets of races must be replaced.

*NOTE: Balls and races must always be replaced in a set because worn races will destroy new balls and worn balls will destroy new races.*

5. Check the dust seal for condition and replace if torn or cracked.

6. Check the steering stem for cracks or a bent condition; this is especially important if the bike has been involved in a spill.

## Assembly

1. Put a coat of a good grade of bearing grease on the steering stem race and the upper frame race.

2. Imbed the ball bearings in the grease. There are 19 balls in each race.

3. Install the steering stem assembly in the frame, holding it in place so that the balls cannot fall out. Fit the top bearing race and bearing cover. Install the bearing adjuster nut. Tighten the nut until all the play is taken out of the steering stem, but insure that the stem can turn freely.

4. The remainder of the procedure is the reverse of disassembly. Tighten the upper triple clamp fitting bolt to 26–29 ft lbs., and the steering stem pinch bolt to 10–16 ft lbs.

5. If the handlebars have been removed, tighten the clamp bolts evenly to yield a gap on both sides of the clamps. Tighten the clamp bolts to 10–16 ft lbs.

## REAR SHOCKS

1. The rear shock absorbers are sealed units. No service is possible. If the shocks leak oil, have a bent damper rod, damaged damper case, or other damage, they should be replaced.

Shock absorbers should be replaced in sets to ensure equal damping characteristics.

2. Shocks can be removed by removing the upper and lower mounts. To remove the spring, set the load adjuster on the softest setting, compress the spring, and remove the spring retainers.

3. With the spring removed, check the damping characteristics of the unit. The damper rod should be able to be pushed into the damper body with considerably less effort than it takes to pull it out. If little or no resistance is felt when pulling a damper rod out, the shock should be replaced. Shocks should have equal damping characteristics.

4. Tighten the mounting bolts to 16–25 ft lbs when installing the shock absorbers.

## SWING ARM

### Inspection

1. Remove the mufflers.

2. Remove the rear wheel, shock absorbers, and chain guard.

3. Measure the distance between the top and bottom shock absorber mounts on both sides. The two measurements must be identical, or the swing arm will have to be replaced.

4. Check that the rear wheel mounting plates are parallel.

5. Grasp the legs of the swing arm and attempt to move it from side to side. Any noticeable side-play (more than 1 mm/0.04 in.) will indicate that the swing arm bushings need replacement.

The swing arm is most likely to be damaged if the machine is operated for any length of time with a broken or otherwise defective shock absorber.

## Removal and Installation

1. Proceed as above. Then remove the swing arm pivot bolt nut and tap out the pivot with a long drift.

2. Remove the swing arm by pulling it straight back. Note the locations of any spacers or shims which may come off. They must be installed in their original locations.

3. The swing arm should be inspected for cracks or fractures, especially around the welds.

4. Remove the bushings, tapping them out with a hammer and punch. Once the bushings are removed, they should be replaced.

5. Lubricate new bushings with a good chassis grease. Press the bushings into the swing arm.

6. Clean out the pivot bolt and ensure that all grease passages are clear. Install the swing arm on the machine. Grease and install the pivot bolt. After tightening the swing arm pivot bolt nut, move the swing arm up and down to ensure that movement is smooth and effortless.

7. Pivot bolt torque is 36–58 ft lbs.